

United States Department of the Interior
National Park Service

National Register of Historic Places
Registration Form

This form is for use in nominating or requesting determinations for individual properties and districts. See instructions in *How to Complete the National Register of Historic Places Registration Form* (National Register Bulletin 16A). Complete each item by marking "x" in the appropriate box or by entering the information requested. If an item does not apply to the property being documented, enter "N/A" for "not applicable." For functions, architectural classification, materials, and areas of significance, enter only categories and subcategories from the instructions. Place additional entries and narrative items on continuation sheets (NPS Form 10-900a). Use a typewriter, word processor, or computer, to complete all items.

1. Name of Property

historic name Rankin Hall

other name/site number Administration Building; Chapel of Tarkio College

2. Location

street & town 402 N. 13th Street N/A not for publication

city or town Tarkio N/A vicinity

state Missouri code MO county Atchison code 005 zip code 64491

3. State/Federal Agency Certification

As the designated authority under the National Historic Preservation Act, as amended, I hereby certify that this nomination request for determination of eligibility meets the documentation standards for registering properties in the National Register of Historic Places and meets the procedural and professional requirements set forth in 36 CFR Part 60. In my opinion, the property meets does not meet the National Register criteria. I recommend that this property be considered significant nationally statewide locally. (See continuation sheet for additional comments.)

Mark A. Miles DECEMBER 29, 2009
Signature of certifying official/Title Mark A. Miles/Deputy SHPO Date

Missouri Department of Natural Resources
State or Federal agency and bureau

In my opinion, the property meets does not meet the National Register criteria. (See continuation sheet for additional comments.)

Signature of certifying official/Title Date

State or Federal agency and bureau

4. National Park Service Certification

I hereby certify that the property is:

Signature of the Keeper

Date of Action

- entered in the National Register.
 See continuation sheet.
- determined eligible for the National Register
 See continuation sheet.
- determined not eligible for the National Register.
- removed from the National Register.
- other, (explain:)

Rankin Hall
Name of Property

Atchison County, MO
County and State

5. Classification

Ownership of Property
(check as many boxes as apply)

Category of Property
(check only one box)

Number of Resources within Property
(Do not include previously listed resources in the count.)

- private
- public-local
- public-State
- public-Federal

- building(s)
- district
- site
- structure
- object

| Contributing | Noncontributing | |
|--------------|-----------------|------------|
| 1 | | buildings |
| _____ | | sites |
| _____ | | structures |
| _____ | | objects |
| 1 | | Total |

Name of related multiple property listing
(Enter "N/A" if property is not part of a multiple property listing.)

Number of contributing resources previously listed in the National Register

N/A

N/A

6. Function or Use

Historic Function
(Enter categories from instructions)

EDUCATION: college

Current Function
(Enter categories from instructions)

VACANT/NOT IN USE

7. Description

Architectural Classification
(Enter categories from instructions)

LATE 19TH AND 20TH CENTURY REVIVALS: Late Gothic Revival
Other: Collegiate Gothic
Other: Tudor Revival

Materials
(Enter categories from instructions)

foundation BRICK
walls BRICK
roof Slate
other Limestone

Narrative Description
(Describe the historic and current condition of the property on one or more continuation sheets.)

See continuation sheet(s) for Section No. 7

8. Statement of Significance

Applicable National Register Criteria

(Mark "x" in one or more boxes for the criteria qualifying the property for National Register listing.)

- A** Property is associated with events that have made a significant contribution to the broad patterns of our history.
- B** Property is associated with the lives of persons significant in our past.
- C** Property embodies the distinctive characteristics of a type, period, or method of construction or represents the work of a master, or possesses high artistic values, or represents a significant and distinguishable entity whose components lack individual distinction.
- D** Property has yielded, or is likely to yield, information important in prehistory or history.

Criteria Considerations

Property is:

- A** owned by a religious institution or used for religious purposes.
- B** removed from its original location.
- C** a birthplace or grave.
- D** a cemetery.
- E** a reconstructed building, object, or structure.
- F** a commemorative property.
- G** less than 50 years of age or achieved significance within the past 50 years.

Narrative Statement of Significance

(Explain the significance of the property on one or more continuation sheets.)

9. Major Bibliographical References

Bibliography

(Cite the books, articles, and other sources used in preparing this form on one or more continuation sheets.)

Previous documentation on file (NPS):

- preliminary determination of individual listing (36 CFR 67) has been requested
- previously listed in the National Register
- previously determined eligible by the National Register
- designated a National Historic Landmark
- recorded by Historic American Buildings Survey # _____
- recorded by Historic American Engineering Record # _____

Areas of Significance

(enter categories from instructions)

EDUCATION _____

ARCHITECTURE _____

Period of Significance

1931 - 1959 _____

Significant Dates

1931 _____

Significant Persons

(Complete if Criterion B is marked above)

N/A _____

Cultural Affiliation

N/A _____

Architect/Builder

Felt, Dunham & Kriehn/Architects _____

Busboom Bros./Builder _____

See continuation sheet(s) for Section No. 8

Primary location of additional data:

- State Historic Preservation Office
- Other State agency
- Federal agency
- Local government
- University
- Other Name of repository:

Tarkio College Alumni Association Archives _____

See continuation sheet(s) for Section No. 9

Rankin Hall
Name of Property

Atchison County, MO
County and State

10. Geographical Data

Acreage of Property .6 of an acre

UTM References

(Place additional boundaries of the property on a continuation sheet.)

1 1/5 2/9/7/1/2/0 4/4/7/9/4/9/0
Zone Easting Northing

2 / / / / / / / / / /
Zone Easting Northing

3 / / / / / / / / / /
Zone Easting Northing

4 / / / / / / / / / /
Zone Easting Northing

Verbal Boundary Description

(Describe the boundaries of the property.)

The "Rankin Hall Tract commence[s] 211.2 feet north and 189.6 feet west of SE corner of Block 29, Rankin Place Addition, Tarkio, MO.; thence north 349.6 feet; thence west 349.6 feet; thence south 160.0 feet; thence east 160.0 to point of beginning."¹ Added to this tract is also a tract of land lying directly east of the previously described tract extending easterly to the west line of 13th Street in the city of Tarkio, Atchison County, Missouri.

Property Tax No. 43-1629473

Boundary Justification

(Explain why the boundaries were selected.)

The Rankin Hall boundary includes the nominated historic building and a few feet of adjacent land on the north, south, and west. On the east, the boundary extends to the property line on 13th Street in order to include the building's historic front lawn with two rows of mature sycamore trees that line the sidewalk to the street. Other Tarkio College buildings are not included because they are either of modern construction or are not contiguous with Rankin Hall.

See continuation sheet(s) for Section No. 10

11. Form Prepared By

name/title see continuation sheet
organization _____ date _____
street & number _____ telephone _____
city or town _____ state _____ zip code _____

Additional Documentation

Submit the following items with the completed form:

Continuation Sheets

Maps A **USGS map** (7.5 or 15 minute series) indicating the property's location.

A **Sketch map** for historic districts and properties having large acreage or numerous resources.

Photographs: Representative **black and white photographs** of the property.

Additional items: (Check with the SHPO or FPO for any additional items)

Property Owner

name/title Heartland Education Institute (Not-For-Profit Organization)
street & number c/o Doug Summa, 1110 McNary Street telephone (660) 736-4957
city or town Tarkio state MO zip code 64491

Paperwork Reduction Act Statement: This information is being collected for applications to the National Register of Historic Places to nominate properties for listing or determine eligibility for listing, to list properties, and to amend existing listings. Response to this request is required to obtain a benefit in accordance with the National Historic Preservation Act, as amended (16 U.S.C. 470 *et seq.*).

Estimated Burden Statement: Public reporting burden for this form is estimated to average 18.1 hours per response including time for reviewing instructions, gathering and maintaining data, and completing and reviewing the form. Direct comments regarding this burden estimate or any aspect of this form to the Chief, Administrative Services Division, National Park Service, P.O. Box 37127, Washington, DC 20013-7127; and the Office of Management and Budget, Paperwork Reductions Projects (1024-0018), Washington, DC 20503.

¹ Wheaton E. Elkins, *Missouri Land Survey of Tarkio College's Rankin Plat.* (Savannah, MO), 9 July 1965.

United States Department of the Interior
National Park Service

National Register of Historic Places Continuation Sheet

Section number 7 Page 1

Rankin Hall
Atchison County, Missouri

Summary:

Rankin Hall, located at 402 N.13th Street in Tarkio, Missouri, is a 3½-story brick and stone building constructed in 1930-31 for the former Tarkio College.¹ The T-shaped, Collegiate Gothic structure served as the Presbyterian college's administration building and chapel, replacing an earlier building on the site which served the same function until it was destroyed by fire in 1930. Designed by Kansas City architects Felt, Dunham & Kriehn, the symmetrical, east-facing building measures 144 feet across the front and extends 141 feet rearward. The building stands on a brick and concrete foundation with a partial basement in the primary north-south block. Rankin Hall is characterized by steep projecting gables with stepped parapets, numerous pointed arch windows, buttresses and a mix of limestone and cast stone trim, all features of its Gothic architecture. It also has a trace of Tudor styling mixed with the Gothic, notably in the design of some windows. The arched main entrance is recessed below a semi-hexagonal two-story bay window in a parapeted cross-gable which projects from the top of the T. Somewhat shorter gables project from the flanking ends and additional gabled projections are on the north, south and west elevations. Leitch Chapel (on the second floor in the rear of the shaft) has stained glass windows separated by tall buttresses. A wide concrete sidewalk flanked by sycamore trees leads from 13th Street to the main entrance. Currently vacant and unused, Rankin Hall is generally well-preserved and intact although some deterioration has occurred due to roof damage and lack of use. Flat sections have been installed over two areas of the roof but this alteration is not visible from the ground. There have been some interior changes but the essential floor plan remains as well as a vast amount of historic material. Overall Rankin Hall retains integrity and reflects its early 20th century appearance as a collegiate building.

Setting

Rankin Hall is situated in the approximate center of the former Tarkio College campus on the west edge of Tarkio in northwestern Missouri. The site is approximately 120 miles from Kansas City and 85 miles from Omaha, Nebraska. Tarkio is small, with a population of approximately 1,935 in 2000. The setting is rural and, in fact, Tarkio College's western boundary is adjacent to farmland. Thirteenth Street bounds the campus on the east, and the town's primary and secondary schools are to the southeast. Across 13th street, residential areas separate the campus from the main highway through Tarkio (Highway 59) as well as from the downtown business district. Today Rankin Hall is one of 20 former campus buildings, most of which were constructed in the 1960s and 1970s. Brown Gymnasium is a few years older than Rankin Hall, and substantially intact, but these two buildings are not contiguous. The

¹Tarkio College closed its doors in 1991 after declaring bankruptcy.

United States Department of the Interior
National Park Service

National Register of Historic Places Continuation Sheet

Section number 7 Page 2

Rankin Hall
Atchison County, Missouri

street entrance to the campus is at the intersection of 13th and McNary Streets. See Figure 10.

Primary (east) elevation

Various elevations of the T-shaped building share many of the same Gothic and Tudor characteristics, but the primary (east) elevation containing the main entrance is the most ornate. Three projecting elements with stepped parapets—taller and more elaborate in the center and shorter and much simpler on the ends—divide the façade vertically. Pairs of brick buttresses with angled stone tops augment the central projection's corners. Horizontally, a concrete water table wraps around most of the building just above ground level and a string course is below the second row of windows. Eight concrete steps lead to the recessed main entrance in the central element. Three multi-light doors and six slender windows are encompassed by the entrance's pointed arch. Directly above is a Tudor-styled, stone-trimmed, semi-hexagonal two-story bay window containing three rows of five casement windows separated by cast stone mullions. In the gable above the bay window is a triple-casement window within a stone enframing. Sides of windows openings and the entrance are quoined. Copper guttering with prominent square downspouts flows along the edge of the slate roof. A limestone cornerstone is just left (north) of the main entrance. Next to this and other entrances throughout the building are original copper hexagon-shaped lamps with gold beveled glass.

Rankin Hall, a strongly symmetrical building, stands 3½ stories with a partial basement and a concrete foundation. It measures 144 feet across the front and is 141 feet deep. Bricks are laid in a common bond (a course of Flemish bond after every five courses of stretcher bond). Quoined limestone trim is generously employed around most entrances and windows.

The primary east facade contains 32 windows in five different shapes and sizes—a mix of Gothic and Tudor. First floor windows are double-casement units with 12 lights per window except for the projecting ends, each of which has a triple-set containing 12 lights. There are eight doubles and two triples. First floor windows have cast stone sills which rest on the water table. Between the projecting ends, the second floor has eight twin lancet casement windows (15 lights each) and a small lozenge above. Each lancet pair is within a stone-trimmed Gothic arch window. Each flanking parapet has a triple-set identical to those on the first floor except containing 15 lights instead of 12. The third floor has a string of five double-hung sash windows with 9/9 lights and one set of double-casement windows on either side of the string with a mirror image on the other side of the central parapet. The projecting ends have triple-sets identical to those on the second floor as well as much smaller double-set gable windows with three lights in each

United States Department of the Interior
National Park Service

National Register of Historic Places Continuation Sheet

Section number 7 Page 3

Rankin Hall
Atchison County, Missouri

casement in the attic. Throughout the building, parapets have cast stone copings and wooden window elements are painted white.

North and south elevations (main block)

North and south elevations of the main block are mirror images. At the west end of both elevations is a gabled, projecting parapet with windows and fenestration similar to that on the flanking parapets on the primary east facade. From east to west, apart from the projecting elements the rest of the first floor has two sets of triple-casement windows with 12 lights in each casement plus one double-set. The second floor has three twin-lancet casement windows identical to those on the east facade. The third floor has two sets of triple double-hung sash windows with 9/9 lights and one set of double-casement windows with 12 lights in each.

Rear (west) elevation

The west elevation of the main block is dominated by the chapel which emerges from the center of the building. The side sections are mirror images with crenellated parapets and similar Gothic arch entrances with double glass doors and 19 lights in the entrance arches. These entrances lead to stairwells, and above the doorways are three-tiered, double-casement windows with varying numbers and sizes of lights, trimmed in stone. Window fenestration is the same as on the north-south elevations, but all are double-hung windows instead of casements and the stone is limited to lugsills. There is rowlock brick trim above the windows, which contain either 9/9 or 6/6 lights. The parapeted projecting elements are located next to the shaft, with slender brick and stone buttresses on both sides.

North and south elevations (Leitch Chapel)

The chapel extends westward from the rear of the main block, forming the base of the T. Its north and south facades are identical, with parapeted gables protruding far enough to provide space for stairwells. Entrances on the west sides of the projecting elements have six-panel wood doors. Five brick buttresses with angled cast stone copings divide the facades vertically, creating four window bays per side. Each bay contains a pointed arch window containing twin lancet casements within a stone, quoined surround with a tiny lozenge at the apex. Unlike generally similar windows in the primary east elevation, chapel windows are narrower and have two smaller twin casements below the lancets. There are 28 stained glass lights in each lancet and 12 in each casement. Directly below the chapel windows are triple-set casements with nine lights each. Each parapeted end has a single casement window with three lights on the first floor, a triple casement set on the second and third floors with six lights each, and a

United States Department of the Interior
National Park Service

National Register of Historic Places Continuation Sheet

Section number 7 Page 4

Rankin Hall
Atchison County, Missouri

slender, three-light window within the gable. All of these windows have cast stone sills and brick trim headers. The chapel walls continue westward for a few feet beyond the projecting elements. A cast stone string course is the only feature on both elevations. Tops of these continuation walls are aligned with the peak of the north-south gable.

Rear (west) chapel elevation

The west facade of the chapel (the bottom of the T) has a multilayered look due to the stepped extensions which are recessed behind it in front of gabled projections on the north and south. The main (west) parapet is stepped and squared off at the top. The main parapet has two triple-sets of double-hung windows with 6/9 lights on the lower level. Between the window sets, a single brick buttress with an angled stone top extends to just above the window line. The second floor has two sets of casement windows with six lights per sash. Above these windows, decorative brickwork and stone suggests a false window arrangement comprised of three vertical areas with a cast stone ledge and three smaller rectangular areas with stone fronts and corners. Above is a slender false window with stone trim. Each west wall of the north-south gabled projections has an entrance with a single, white-painted six-panel wood door within a stone surround. Above each of these entrances, a single casement window with eight lights is midpoint in the wall. Each extension wall has three single casement windows in a vertical row (one on each floor).

Roof

The lively roofline features projecting, stepped gables of steel beam and wire mesh construction. The central main gable runs east-west and crosses a smaller and lower north-south gable in the middle of the building. The two flanking east-west gables flow into the sides of the north-south gable. A much smaller north-south gable intersects the west end of the chapel. The roof is finished with black slate and lined with copper guttering. Visible only from above, two rectangular foam segments are positioned on the main block between the three front-facing gables. The north segment is coated with tar and the south segment is coated with urethane. A stone coping marking the intersection of these two main gables is only visible from above.

Interior

The interior of Rankin Hall has experienced minor change over the years, but substantially retains its original floor plan and finishes. All three floors are similar in design, with a hallway down the center of the building in a north-south direction with offices and classrooms in the exterior rooms. Stairwells are located on either side of the chapel. Terrazzo marble flooring covers the hallways and stairwells and tongue and

United States Department of the Interior
National Park Service

National Register of Historic Places Continuation Sheet

Section number 7 Page 5

Rankin Hall
Atchison County, Missouri

groove, three-inch plank wood floors are found in the classrooms and offices. Throughout the interior, dark wood trim is used around the windows, along the floor and ceiling, and on some walls. Interior doors are made of solid wood in three different styles: six-paneled Gothic arched doors with brass handles, French doors with 15 lights, and wood flush doors. Solid wood built-in cabinetry is found in the main administrative offices. The building has its original suspended ceiling lamps in the hallways and lantern-style suspended luminaire in the chapel and entryway. The original clock/bell system is intact in the hallways. Interior walls and ceilings are plastered and painted. Interior window sills are marble. The original heat radiators are intact on all floors and in the stairwells.

The main entrance leads to a small foyer with a set of triple multi-light doors with side-lights. Encased in wood, this entry has lacy cresting above the lintels. A wide marble staircase ascends to the second floor and two smaller, flanking staircases lead down to the first floor. Railings are wrought iron with an intricate design at the base of the posts. At the top of the stairs is the entrance to the chapel. The second floor contained the president's office and other administrative offices, plus the campus switchboard, the mathematics department in the south wing, and the library in the north wing. A walk-in safe from Cramer Brothers Safe Co., Kansas City, is intact in the second floor administrative offices.

Leitch Chapel, with seating for 600, is intact on the second floor. Its Gothic design is apparent in its arched doorways, arched stained glass windows and suspended, lantern-style light fixtures with a Tudor floral motif. The recessed, pointed arch entry contains six-panel double doors leading into a small foyer outside the chapel. A slight incline leads to the stage. Wooden pews are on both sides of the nave. Identical double doors at the stage rear are flanked by single arched doors, and there are exit doors as well. The stained glass windows feature religious symbols in selected panes. The plastered, vaulted ceiling consists of simple ribbing with vaulting shafts interwoven with steel girders.

The first floor of Rankin Hall was used for classrooms, and the original banquet hall (cafeteria) was located under the chapel. The banquet hall was one large room with a small kitchen under the chapel stage. Photos show a walkway around the top of the room. The third floor—originally all classrooms and staff offices—has an entrance to the chapel balcony.

Two types of steam heat are used in the building, air and radiating. In the basement are two air handlers and separate heating lines for two other buildings no longer in existence. Some basement walls have masonry over broom-finished clay tile blocks. A partial attic is within the cross gables.

United States Department of the Interior
National Park Service

National Register of Historic Places Continuation Sheet

Section number 7 Page 6

Rankin Hall
Atchison County, Missouri

Integrity

Relatively unaltered, the exterior of Rankin Hall easily retains integrity. The interior is substantially intact but was modified on at least three occasions. In 1960-61, the first floor dining hall was converted into a library and some classrooms were updated. When Thompson Library was completed in 1968, the original library space in Rankin Hall was converted into an art studio. In the 1990s, work included the installation of window air conditioning units, updating of the steam control valves and bathrooms, and renovation of some offices and the chapel. The two flat roof sections also were installed in the 1990s. Despite minor renovation in the 1990s, the second floor including the chapel remains the most intact area of the building. Overall, Rankin Hall is in fair to good condition but leaks in its slate roof and other deterioration due to neglect and lack of use have taken a toll. Water damage is most evident, especially in the east facade along the center parapet and the ceiling of the third floor hallway at the south end of the building. Rankin Hall has been vacant since 2005.²

²In January 2007, HMN Architects, Inc. estimated the cost of repairs to walls, ceilings, windows and doors at more than \$22,000, an amount that is almost certain to be higher today.

United States Department of the Interior
National Park Service

National Register of Historic Places Continuation Sheet

Section number 8 Page 7

Rankin Hall
Atchison County, Missouri

Summary:

Rankin Hall, 402 N. 13th Street, Tarkio, Missouri, is eligible for listing in the National Register of Historic Places under Criteria A and C with local significance in the areas of EDUCATION and ARCHITECTURE, respectively. Designed by noted Kansas City architects Felt, Dunham, & Kriehn, the Collegiate Gothic-style Rankin Hall was constructed in 1931 to replace a previous administration building and chapel on the Tarkio College campus which had burned. A private, co-educational United Presbyterian institution with a strong commitment to the liberal arts tradition, Tarkio College served the higher education needs of northwest Missouri, southwest Iowa and areas of Kansas and Nebraska from its founding in 1883 until its demise in 1991, and Rankin Hall was the nucleus building for most of this period. For many years Rankin Hall contained not only the administrative and departmental offices but also the majority of the college's classrooms, its library, its cafeteria and Leitch Chapel (which served a dual role as a public auditorium). Tarkio College impacted its area economically as well as educationally and culturally, and in turn was strongly supported by the local community in time of need. Tarkio College became a member of the Missouri College Union in 1902, and remained open through the Great Depression when many other small, private institutions across the state closed. Rankin Hall, one of only two buildings on the Tarkio campus that predate World War II, is also noteworthy for its Collegiate Gothic styling reflected in numerous steep gables with stepped parapets, pointed arch windows and entrances, buttresses and extensive limestone and cast stone trim.³ The period of significance is 1931 through 1959, the date of Rankin Hall's completion through the year when activities begun historically continue to have importance and no more specific date can be defined.

Historical Background

Tarkio began as a railroad town, one of three laid out across Atchison County in 1880 by Chicago, Burlington & Quincy mogul Charles Elliot Perkins. Also buying land along the CB&Q's projected path were Tarkio founding fathers David Rankin, John Stevenson and W. Miller. The CB&Q was the first railroad to establish a direct route from Chicago to Denver, and Tarkio was fortuitously situated on its Tarkio Valley Branch. Tarkio grew quickly and was sufficiently prosperous to rival the county seat at Rock Port for a courthouse when a new one was needed in 1882-1883.⁴ Tarkio actually constructed a courthouse "on spec" during this period, with David Rankin apparently spearheading the effort, but the new \$40,000 building—located where the current Tarkio Presbyterian

³ Brown Gymnasium, built in 1924, is the other campus building that predates World War II.

⁴ *Tarkio Avalanche*, February 25, 1888; *Tarkio: the First 100 Years* (Shawnee Mission, KS: Kes-Print, [S.l.: s.n., 1980?]), 4; S. W. Skelton, "Early History of Atchison County" (Unpublished, Atchison County, MO, 1954), 12.

United States Department of the Interior
National Park Service

National Register of Historic Places Continuation Sheet

Section number 8 Page 8

Rankin Hall
Atchison County, Missouri

Church stands at 700 Maple Street—became available for other purposes, i.e., a college, when after a vote the county seat remained at Rock Port. Over the years until his death in 1910, Rankin, a highly successful agriculturalist, remained Tarkio's primary benefactor.

Mrs. W. O. Miller, whose husband was a member of Tarkio College's first board of directors, has been credited with suggesting that the speculative courthouse be utilized as an educational institution. While walking past the vacant building with Mrs. Miller and two others, David Rankin is said to have lamented its fate and appealed to the group for ideas. "Mrs. Miller...supplied with little deliberation, 'Why not make it into a United Presbyterian school?' Within the hour David Rankin was beginning to settle details of Tarkio College."⁵ Today Rock Port remains the county seat but Tarkio, despite the loss of its college, has the higher population.

The Tarkio Valley College and Normal Institute began as a private academy (in 1882) but quickly became a joint venture of the town and the United Presbyterian Church (in 1885) before the church assumed full fiscal responsibility for its operation (in 1887). At the time there were two other Presbyterian colleges in Missouri destined for membership in the Missouri College Union, an organization of four-year liberal arts colleges, but Tarkio was the only one supported by the United Presbyterian denomination. (As late as 1956, Tarkio College was one of only six United Presbyterian colleges in the nation.)

Whether classes were actually held as early as 1882 is unclear, but when the Tarkio Valley College and Normal Institute opened on August 13, 1883, there were 11 students and Samuel C. Marshall (already president of Amity College at College Springs, Iowa) was president of the board of managers. Enrollment grew quickly, and by year's end there were approximately 64 students. In January 1885, a new charter shared control of the college with the United Presbyterian Synods of Kansas and Iowa. In June 1887, the citizens of Tarkio relinquished total control of the college to the United Presbyterian Synods of Iowa and Kansas on the condition that a \$30,000 endowment be raised. Later the Nebraska Synod joined in the charter and the Kansas Synod withdrew (in 1889) after establishing its own academy. While denominational, Tarkio College was considered nonsectarian since three of the trustees were "elected by the board of directors, irrespective of church affiliations."⁶ The long school name was shortened to

⁵"Tarkio College Anniversary," *The Christian Union Herald* (Pittsburg, PA), October 1933), 7.

⁶ Atchison County Deed Book. "Articles of Association of the Tarkio College." Book 37, 14 February 1885, 526-533; Walter Williams, ed., *A History of Northwest Missouri*. (Chicago and New York: Lewis Publishing Co., 1915), 332; *Avalanche*, February 25, 1888, Special Section: "1884 – 1984 Tarkio's Progress...", July 26, 1984, sec B 12; Tarkio College Bulletin, Forty-Eighth Annual Catalogue, 1930-31, March 1931, Series 27, No. 2, 10.

United States Department of the Interior
National Park Service

National Register of Historic Places Continuation Sheet

Section number 8 Page 9

Rankin Hall
Atchison County, Missouri

simply Tarkio College.

Tarkio College soon assumed a leading role in the education of Missourians in the northwest corner of the state. As early as 1888, the *Tarkio Avalanche* asserted that the college “filled a long-felt want in this part of the state.....The fame of the college is extending annually and it is rapidly building up an enviable reputation for so young an institution.”⁷

Unfortunately Tarkio College was plagued by fires, and on January 17, 1892, the original building was destroyed by the first of several blazes. (Ironically, the school’s motto was “Set fire, Tarkio!”) Citizen donations of \$15,000 at a town meeting the day after the fire were matched by David Rankin, and that summer Tarkio College not only rebuilt but expanded, purchasing approximately 15 acres in Block 29 of Rankin Place Addition from William F. and Lizzie Rankin for \$4,000. The Main, a Romanesque Revival-style building with a seven-story bell tower, was constructed on the site where Rankin Hall stands today. Also built at this time were a women’s dormitory known as Marshall Hall and a men’s dormitory called Owl’s Roost (an owl was the Tarkio College mascot), to the south and north, respectively, of the Main. Neither of these old dormitories is extant.⁸

Upon David Rankin’s death on October 18, 1910, Tarkio College lost its primary benefactor but became \$100,000 richer thanks to his generous bequest. Rankin, who died at the age of 85, reportedly donated a total of \$235,000 to the college over his lifetime. Also in 1910, Tarkio College received a donation of \$12,500 from Andrew Carnegie to help pay debts and construct a new dormitory for men—Thompson Hall, which replaced the Owl’s Roost.⁹ Thompson Hall is not extant.

Another major fire occurred on November 23, 1915, when a blaze damaged the Main’s clock tower and destroyed its upper floors. Insurance covered the cost of repairs in this case, although the tower as reconstructed was greatly attenuated. The campus expanded in 1924 with the acquisition of 29 more acres from the Rankin family, and Brown Gymnasium (extant) was built.

The Main burned again on January 20, 1930, and this time the conflagration destroyed the building. The amount of insurance was only \$25,000, not nearly enough to finance

⁷*Tarkio Avalanche*, February 25, 1888.

⁸*The Tarkio Independent* (Tarkio, MO), January 22, 1892; Williams, *A History of Northwest Missouri*, 332; Atchison County Deed Book, Warranty Deed. Book 47 (June 18, 1892), 625; *The Tarkiana*, Tarkio College Yearbook, Junior Class (Tarkio, MO), 1924; Craig and Naylor, 6, 26.

⁹*Tarkio Avalanche*, October 27, 1910 and November 26, 1915; Craig and Naylor, 20.

United States Department of the Interior
National Park Service

National Register of Historic Places Continuation Sheet

Section number 8 Page 10

Rankin Hall
Atchison County, Missouri

construction of a comparable replacement building.¹⁰

Once again, however, the citizens of Tarkio and other supporters of higher education in northwestern Missouri came through with financial assistance. An article in the *Tarkio Avalanche* (written by Dr. J. A. Thompson, the college president) reminded readers that Tarkio College had been the primary employer not only in Tarkio but throughout Atchison County, and stressed the importance of replacing the administration building if the town and college were to enjoy continued prosperity. Asked to donate amounts of from \$25 to \$1,000, Tarkio businessmen and other supporters were quick to respond with contributions. Within a week, some \$51,500 had been raised toward construction of a new Main building.

When Dr. Thompson retired later that year, Dr. Robert N. Montgomery became the president and, as such, was in charge of construction. After unspecified changes were made to the original plans of Felt, Dunham & Kriehn, construction was authorized to begin on June 3, 1930. Groundbreaking ceremonies were held on October 21, 1930, and the cornerstone was laid on December 18, 1930. The general contractor was Busboom Bros. of Fairbury, Nebraska. Constructed on the same site as the previous Main, the new Main cost \$159,000. It was completed in August 1931.

In 1938, the new building was named Rankin Hall in honor of agriculturalist-businessman David Rankin, Tarkio College's original benefactor. A member of the United Presbyterian Church, Rankin was self-educated but believed strongly in the importance of formal higher education. Rankin, whose success in agriculture was attributed to his use of then-innovative methods, apparently assisted the college whenever the need was urgent, above and beyond his ongoing support. In addition to his wildly profitable farms (which reportedly produced more than a million bushels of corn a year), Rankin had important local business interests. He was president of the First National Bank of Tarkio, the Rankin Water Company, the Rankin Light and Power Company and the Rankin Auditorium Company, all of Tarkio. Rankin's mule barn, an octagonal brick structure constructed near Tarkio in the early 1890s, had been renovated and was used as a theater by Tarkio College until February 1989. On that date it burned, becoming yet another casualty in the series of fires that have plagued the campus over the years.¹¹

¹⁰ *The Tarkio Independent* (Tarkio, MO), January 22, 1892; Williams, *A History of Northwest Missouri*, 332; Atchison County Deed Book, Warranty Deed. Book 47 (June 18, 1892), 625; Craig and Naylor, 6, 26; *Tarkio Avalanche*. (Tarkio, MO), January 24, 1930.

¹¹ Tarkio College Bulletins and Annual Catalogues for 1934 and 1938, Tarkio MO: Tarkio College, s. 30, no. 1 (March 1934): 8 and s 34, no. 1 (1938); M. Patricia Holmes, "Mule Barn Theatre," National Register of Historic Places nomination, 1970; *A Biographical History of Nodaway and Atchison Counties, Missouri* (Chicago: Lewis Publishing Co., 1901), 621-623. The barn was listed in the National Register

United States Department of the Interior
National Park Service

National Register of Historic Places Continuation Sheet

Section number 8 Page 11

Rankin Hall
Atchison County, Missouri

Education

Rankin Hall, the nucleus building of Tarkio College, is significant under Criterion A in the area of EDUCATION. Founded in 1883 by the United Presbyterian denomination, Tarkio College served the higher educational needs of a four-state region consisting of northwest Missouri, southwest Iowa, northeast Kansas and southeast Nebraska until 1991. Rankin Hall, from its construction in 1931 until bankruptcy was declared in 1991, was an indispensable building on the Tarkio campus. Like other Christian colleges, Tarkio was strongly committed to the liberal arts tradition and its enrollment was limited by design in order to retain the advantages of a small student body and small classes. Tarkio's acceptance into the Missouri College Union in 1902 testified not only to the quality of its product but to its financial stability as well. Rankin Hall functioned as the administrative center, housed departmental offices and the campus library, and over the years thousands of students were educated in its classrooms. Rankin Hall also housed Leitch Chapel, which beyond its ongoing religious function was the site of numerous cultural events and entertainments attended by members of the larger public as well as students.

The nation's earliest colleges were founded by Christian churches, and after the Civil War Missouri churches displayed a continuing interest in the establishment of academic schools and colleges. Tarkio College was the only *United* Presbyterian-sponsored college in Missouri to thrive, but three other Presbyterian-sponsored colleges also achieved membership in the Missouri College Union: Missouri Valley College at Marshall (established 1889); Park College at Parkville (established 1875); and Westminster College at Fulton (established 1849). Throughout the nation, the proportion of United Presbyterian-sponsored colleges to other Presbyterian colleges remains low today.

The original Articles of Association for Tarkio College were simply stated: "The object and purpose of this association shall be that establishment and maintenance of a college or School of instruction in the arts [,] sciences and literature and with the power or occasion may require of establishing a Preparatory Department and departments for instruction in any of the learned professions such as Theology [,] Medicine [,] and also for the instruction of Teachers and the like."¹² The Articles of Association (as amended in 1931 and 1950) more precisely address the mission of Tarkio College during the period of significance:

(as the Mule Barn Theater) on 10/15/70.

¹² Atchison County Deed Book, "Articles of Association of the Tarkio College," Book 37, February 14, 1885, 526-533.

United States Department of the Interior
National Park Service

National Register of Historic Places Continuation Sheet

Section number 8 Page 12

Rankin Hall
Atchison County, Missouri

The program of the college is organized to meet the needs of the surrounding area both academically and in the extra-academic services which are offered by the College, which is the only Christian liberal arts College located in a 50,000 square mile area of the middle west. It is the plan of the College to limit enrollment to 300 students in order to retain the advantages associated with a small student body and small classes. The value of the personal contact of faculty and students, both in and out of class is realized and protected. The main purpose of the College program is to provide an atmosphere in which students will learn enough of the heritage of past ages in all realms of knowledge that they can wisely chart their own paths through life as well as the path of western civilization. It is only as we are aware of the prior attempts, successes and failures, in all realms of human endeavor, that we can chart our own course through life, and influence the path of western civilization.

By 1902, Tarkio College had come a long way from its humble beginnings. It had met the requirements for membership in the Missouri College Union, joining existing members Missouri State University, St. Louis University, William Jewell College, Westminster College, Washington University, Central College, Drury College, Park College and Missouri Valley College. Later members included Central Wesleyan College, Culver-Stockton College and Lindenwood College. The Missouri College Union sought to raise the standards of higher education, maintain a forum for the discussion of educational issues, make recommendations regarding policies and practices, and foster communication among faculty members. In addition to meeting minimum requirements for membership, admission to the Union needed a two-thirds vote for approval, so it was a credit to Tarkio's high educational standards, size and diversity of the curriculum and teaching force, equipment and financial stability (the amount of its endowment) that the college was accepted into the Union. In 1922 Tarkio College became a member of the North Central Association of Colleges and Secondary Schools, another standardizing organization, for the first time as well.¹³

Tarkio's enrollment was relatively small but was about average for a Christian liberal arts college in Missouri. As spelled out in the Articles of Association, a small student body was considered optimum for the transfer of knowledge. Complete enrollment information was not obtained for Tarkio College, but in 1911 it was reported as 303, with 95 in the "college proper" and there were 22 teachers. In 1917 (during World War I) the total enrollment was 150 of which 112 were enrolled in college classes. In 1939, there were 212 full-time college level students at Tarkio and in 1947 (bolstered by returning GIs) Tarkio enjoyed its largest enrollment (437) of which 269 were full-time college-level students. In 1959, the closing date of the period of significance, there were 295

¹³ *Tarkio Avalanche*, February 25, 1888, Special Section: "1884-1984 Tarkio's Progress...", July 26, 1984, sec B 12; *Tarkio College Bulletin*, Forty-Eighth Annual Catalogue, 1930-31, March 1931, Series 27, No. 2, 10; Clyde A. Phillips, *A History of Education in Missouri*, Jefferson City, Missouri: The Hugh Stephens Printing Co., 1911, 151-156.

United States Department of the Interior
National Park Service

National Register of Historic Places Continuation Sheet

Section number 8 Page 13

Rankin Hall
Atchison County, Missouri

students.¹⁴

Tarkio College contributed to the educational experience of generations of students, many of whom have distinguished themselves in various fields of endeavor. Science and mathematics were two of Tarkio's strongest fields, and some of the college's more successful graduates in those fields include Wallace Carothers, credited with the invention of nylon while employed by DuPont in 1935; Dr. John Waugh, who became chief of abdominal surgery at the Mayo Clinic; Dr. Charles D. Oviatt, a science editor for McGraw-Hill Publishing Company; Leonard R. Hache, noted for developments in the use of dry ice; Dr. Joseph L. Woodruff, who conducted well-publicized experiments in extrasensory perception while at Duke University; Quentin Bartz, noted for research into the uses of penicillin; and James A. Kime, a biochemist. Another notable Tarkio graduate was Rear Admiral Neil M. Stevenson, chief of chaplains for the U.S. Navy. Although his education at Tarkio occurred prior to the period of significance for Rankin Hall, prominent archeologist/anthropologist Edgar Lee Hewett (who helped bring about the Antiquities Act of 1906) certainly should be mentioned. Perhaps an unlikely training ground for professional football players, Tarkio contributed in that area as well: Allen Reynolds, a former Tarkio Owl, played professional football for nine years with the Kansas City Chiefs. Tarkio also is represented in the Helm Foundation Hall of Fame: basketball coach Newton P. Kyle and team captain Melford Waits were both inducted into Helm after the Owls won the 1940 NAIA Championship.¹⁵

Tarkio College graduates have been recognized in various publications for their achievements. In 1990, *Life Magazine* included Carothers on its list of "The 100 Most Important Americans of the 20th Century." Such prestigious publications as *Scientific American*, the *New York Times*, the *St. Louis Post-Dispatch* and the *Journal of Para-Psychology* all reported Tarkio's partnership with Duke University in pioneering 1930s experiments in the field of extra-sensory perception. *Who's Who in America* reported that one of every 81 male graduates of Tarkio College between 1920 and 1949 was listed in its 1956-57 edition. One of every 23 male graduates of Tarkio College between 1903 and 1951 was included in the 1957 edition of *American Men of Science*.¹⁶

As a church-supported college, Tarkio also had a chapel (Leitch Chapel, located on the

¹⁴Enrollment data are from various sources including annual reports of public schools in Missouri; Articles of Association of Tarkio College (as amended); a published "Report to the People of Tarkio from Tarkio College;" and an interview with Gordon Dixon Collins.

¹⁵Gordon Dixon Collins, "The Merits of Rankin Hall." Unpublished comments in possession of Joni Amthor, September 16, 2009. Dr. Collins, son of Tarkio College's fourth president, is a retired professor of psychology at Wooster College, Wooster, Ohio;" St. Clair.

¹⁶Ibid; Professor R. F. Patterson, "Tarkio Psychology Experiments." *The United Presbyterian* 96, no. 25 (June 23, 1938): 14; "The 100 Most Important Americans of 20th Century," *Life Magazine*, Special Issue, Fall 1990, Vol.13, No. 12, 76.

United States Department of the Interior
National Park Service

National Register of Historic Places Continuation Sheet

Section number 8 Page 14

Rankin Hall
Atchison County, Missouri

second floor of Rankin Hall)—but the chapel was used for much more than religious services. Leitch Chapel was also important as a public auditorium in northwestern Missouri. Gordon Collins, son of Dr. M. Earle Collins, president of Tarkio College from 1932-1951, recalled that Leitch Chapel “was the only place for the city of Tarkio, all of Atchison County and parts of Southwestern Iowa to hear the best of educational lectures and even be mesmerized by a magician or two. It was the largest enclosed and acoustically excellent space in all of Atchison County.” Leading educators spoke there, he said, along with “every significant person in the United Presbyterian Church over a period of 50 years.” Kansas City Mayor H. Roe Bartle and Tennessee Senator Estes Kefauver, running mate of 1956 Democratic presidential nominee Adlai Stevenson, were among politicians making presentations in Leitch Chapel. Lecturers from the Chautauqua series appeared there from at least 1931 through the 1950s.¹⁷ The chapel was also used for public music recitals and Little Theater performances as well as required religious services for the students and Religious Emphasis Week activities.¹⁸

The Tarkio College founders, many of whom had attended Monmouth College in Monmouth, Illinois, were all “earnest Christian men whose purpose [was] to establish a thoroughly Christian institution.”¹⁹ This affiliation with Monmouth College brought many advantages including strong presidents and faculty members who enabled Tarkio to compete successfully with other small private colleges in Missouri. Tarkio College presidents involved in the construction or operation of Rankin Hall were Dr. Joseph Addison Thompson (1887-1930), Dr. Robert Nathaniel Montgomery (1930-1932), Dr. M. Earle Collins (1932-1951) and Dr. Clyde Henry Canfield (1952-1959), all known for their educational excellence. Their leadership inspired the board, students, alumni, residents of Tarkio and the United Presbyterian Church to keep Tarkio’s doors open during the Great Depression and World War II, periods during which many other small private colleges were permanently closed.

President Thompson, Tarkio’s second president, had been valedictorian of Monmouth College’s class of 1882. Dr. Thompson pushed successfully for Tarkio’s membership in the Missouri College Union in 1902 and the North Central Association of Colleges and Secondary Schools in 1922. At Tarkio, he instilled a “high regard for religious truth and moral worth.”²⁰ His goals were to develop in students “Christian character, scholarship, culture, efficiency, health and inspiration.”²¹

¹⁷ Collins, “The Merits of Rankin Hall.”

¹⁸ *Tarkio College Bulletin, Sixty-Sixth Annual Catalogue*, s 45, no. 1, (March 1949).

¹⁹ *Fifth Annual Catalogue*, Tarkio, MO: Tarkio College (1887-1888).

²⁰ Craig and Naylor, 4.

²¹ *Ibid*, 16.

United States Department of the Interior
National Park Service

National Register of Historic Places Continuation Sheet

Section number 8 Page 15

Rankin Hall
Atchison County, Missouri

When the Main was destroyed by fire in January 1930, Dr. Thompson was instrumental in getting the rebuilding campaign off the ground. Predicting a grim economic future for Tarkio without the college, he appealed for donations in an article published in the *Tarkio Avalanche* and reprinted in *The United Presbyterian*. Pointing out that there was not another Christian college of any denomination within 125 miles of Tarkio, Dr. Thompson suggested annuity bonds at four to nine percent interest to pay for reconstruction. By the time Dr. Thompson retired in May 1930, a substantial amount of money had been raised for a new administration building and the fund was still growing.²²

Upon Dr. Thompson's retirement in 1930, Dr. Montgomery became Tarkio's third president. Only 30 years old, President Montgomery was the youngest president ever to serve the college. He left after two years but during his tenure was responsible for virtually every aspect of the building that became Rankin Hall, from working with the architect during the design and construction phases to securing sufficient funds to pay for it.²³

Dr. Collins became Tarkio's fourth president in 1932, ultimately providing 19 years of leadership during critical times. While small colleges throughout the state were closing as enrollments declined, President Collins managed to keep Tarkio open by reestablishing its financial footing.²⁴ During World War II, Tarkio's existence was virtually month-to-month as President Collins urged alumni to purchase war bonds in the college's name and traveled to cities as far away as Chicago to solicit funds for operating expenses. By the end of Dr. Collins' term, the school's debts had been paid and a \$600,000 development program implemented. In 1947, Tarkio College had a peak enrollment of 437, of which 269 were full-time college level students.²⁵

Dr. Clyde Henry Canfield became president in 1952, continuing President Collins' expansion program in the face of continued financial pressure at a time when the net worth of the college was \$1,759,101 and the endowment fund stood at \$719,132. In 1953, however, although the student body represented 17 states and several foreign countries, enrollment had fallen below an optimum level and the Canfield

²² Jenison, 90-91; *Tarkio Avalanche*, January 24, 1930-February 17, 1930, 1, 4; J. A. Thompson, "Tarkio College—Why It Should be Promptly Rebuilt," *The United Presbyterian* (27 February 1930); J.A. Thompson, "Tarkio College: A Brief History," *Tarkio College Bulletin*, Fiftieth Anniversary Celebration Edition, s 29, no. 3 (October 4, 1933), 7.

²³ Ibid.

²⁴ Ibid.

²⁵ Gordon Dixon Collins, phone interview by Joni Amthor, September 6, 2009, Tarkio, MO; "Story in Pictures of Tarkio College's Seven-Project Development Program, During the Years 1945-1950, at an Expenditure of \$600,000," *The United Presbyterian* 108, no. 31 (July 31, 1950); M. Earle Collins, fourth president of Tarkio College, *Tarkio College Bulletin*, Commencement Issue, s 43, no. 4 (April 1947).

United States Department of the Interior
National Park Service

National Register of Historic Places Continuation Sheet

Section number 8 Page 16

Rankin Hall
Atchison County, Missouri

administration embarked on a (successful) plan to increase enrollment and raise additional funds. In 1957, for example, the Tarkio College budget included \$92,000 from the Ford Foundation. Without the foresight and efforts of its presidents and the backing of the United Presbyterian Church, Tarkio College almost certainly would not have survived these challenging years. Tarkio remained competitive even with such older private schools as the Baptist William Jewell College (Liberty) and the Presbyterian Westminster College (Fulton).²⁶

The character of the institution was important to the success of Tarkio College, and it remained high throughout the period of significance. And, quoting Gordon Dixon Collins, Rankin Hall “was the heart and soul...of the Tarkio College campus, from its construction in 1931, until the close of the college in 1992. There would be few other buildings in the state of Missouri that would have had a singular impact on a community or region as David Rankin Hall did on the campus of Tarkio College during those...[significant] years.”²⁷

Architecture

Rankin Hall is also locally significant under Criterion C for ARCHITECTURE as an uncommon example of the Collegiate Gothic style in rural, northwestern Missouri. The building is distinguished by its many steep gables with stepped parapets and numerous pointed arches. Evolving from the Gothic Revival architecture of 1840-1860, Collegiate Gothic peaked in the U.S. roughly between 1890 and 1930, generally as a popular style on American college campuses following the lead of Cambridge and Oxford. It was a period during which older architectural forms were enthusiastically revived and reworked.

Gothic architecture was believed to be the only style “based on the fundamental tenants of the Christian faith.”²⁸ Style was important because it was believed that a building’s character reflects the conditions of society. Rankin Hall’s character is based on its Christian background and the faith of those it served in its region. Built during the Great Depression, Rankin Hall was a symbol of hope during this bleak time in the nation’s history.²⁹

²⁶ H. Clyde Canfield, fifth president of Tarkio College, “Financial/Fact Sheet of Tarkio College,” Tarkio College Alumni Archives, Tarkio, MO (1959); The Tarkio Board of Directors 1951-1952, letter for support to William Kirk, Ph.D., Tarkio College Alumni Archives, Tarkio, MO, n.d.

²⁷ Collins, “The Merits of Rankin Hall.”

²⁸ George L. Hersey, *High Victorian Gothic: A Study in Association*, (Baltimore, MD: Johns Hopkins Press, 1972), 44.

²⁹ Phoebe B. Stanton, *The Gothic Revival & American Church Architecture: An Episode in Taste 1840-1856* (Baltimore, MD: The John Hopkins Press, 1968), 167.

United States Department of the Interior
National Park Service

National Register of Historic Places Continuation Sheet

Section number 8 Page 17

Rankin Hall
Atchison County, Missouri

Collegiate Gothic of the 1880s represented a new vision from a new generation of architects. It was designed with Gothic quads and, for the middle class, became more refined and scaled down in size with less elaboration. Prior to the 1930s, it was often mixed with Tudor styling and this blending is seen in Rankin Hall, where windows in particular show Tudor affinities. This form of eclecticism, mimicking the architecture at Oxford and Cambridge, was in vogue at architectural schools when Rankin Hall was constructed, and was favored by many universities.³⁰

Muskingum College in New Concord, Ohio, may have influenced the design of Missouri's Rankin Hall. Like Rankin Hall, Muskingum also has a Scot-Irish Presbyterian background and in fact shared a president with Tarkio College, Dr. Robert N. Montgomery. President Montgomery's father, Dr. J. Knox Montgomery, president of Muskingum College from 1904-1931, was in charge of a major building project there in 1921, and preceded his son as president of Muskingum College. There are similarities in their designs—not so much in the fine details as in the general design.³¹ See Figure 13.

Rankin Hall was designed by the architectural firm of Felt, Dunham, and Kriehn of Kansas City, Missouri. Senior partner John Henry Felt, self-educated in the field of architecture, started the firm in 1909. Felt, who grew up in Greenfield, Indiana, opened his first practice as J. H. Felt & Co. in 1898-1908 in St. Joseph, Missouri. Felt's Kansas City office was operational from 1909-1938. By 1926, Felt was senior partner with H. H. Dunham and Arthur Kriehn. Dunham had operated a branch office in Mason City, Iowa before joining Felt in Kansas City. Dunham left the firm in 1936. During his career Felt published a monthly magazine, *Modern Architecture*.³²

³⁰ Marcus Whiffen and Frederick Koeper, *American Architecture 1607-1976*, (Cambridge, MA: The MIT Press, 1981), 289-190; Alan Gowans, *Styles and Types of North American Architecture: Social Function and Cultural Expression* (New York: Harper Collins, 1992), 144, 159, 220-224, 255 -256; Ralph W. Hammett, *Architecture in the United States: A Survey of Architectural Styles since 1776*, (New York: John Wiley & Sons, 1976), 121.

³¹ Craig and Naylor, 1; Monmouth College, "College History of Monmouth College," Monmouth College, Monmouth, IL (July 6, 2009), <http://www.monm.edu/aboutus/history.aspx>; Gowans, 158-159; Muskingum College. "About Muskingum College," Muskingum College, New Concord, Ohio (July 1, 2009), <http://www.muskingum.edu/home/about/overview.html>

³² Felt, Dunham & Kriehn, Architects of Kansas City, MO, "Blueprints and General Plan of the Administration Building and Chapel of Tarkio College, Tarkio, MO," September 12, 1930; Marian M. Ohman, "Oh! Justice... ." *The History of Boone County, Missouri Courthouses* (Columbia, MO: University of Missouri-Columbia Extension Division, 1979), 24, 43; Bethanie C. Grashof, "Historic American Buildings Survey (HABS No. Mo-1224)—Rockford School, Jackson County, Missouri," (September 1978), 1; Henry F. Withey and Elsie Rathburn Withey, *Biographical Dictionary of American Architects (Deceased)* (Los Angeles: Hennessey & Ingalls, Inc., 1970), 206-207.

United States Department of the Interior
National Park Service

National Register of Historic Places Continuation Sheet

Section number 8 Page 18

Rankin Hall
Atchison County, Missouri

Felt and his associates were relatively prolific, designing many churches and schools in Missouri, Kansas, Oklahoma, Nebraska and Iowa. Floor plans for one, four and eight-room schools designed by Felt are even included in the 1911 and 1912 (and probably other) editions of Missouri's annual public school reports. Examples of Felt's work include the Boone County Courthouse, Columbia, Mo. (1908); the Administration Building at Teachers' College, Northwest Normal/Northwest Missouri State University, Maryville, Mo. (1910); Senior High and Junior High Schools, Emporia, Kans. (1926); the Science Hall (1913) and Administration Building at Emporia College, Kans. (1926); Paseo Baptist Church, Kansas City, Mo. (1927; completed 1942); First Presbyterian Church, Independence, Kans., high schools at Lexington, Mo. (1927), High School, Hannibal, Mo. (1932), and Butler, Mo. (ca. 1910); State School at Marshall, Mo.; and buildings on the William Jewell College campus at Liberty, Mo. Felt died in 1938, seven years after Rankin Hall was built.³³

Apparently one of the last (if not the last) buildings designed by Felt for a college campus, Rankin Hall is a remarkable example of a Collegiate Gothic style building located in the heart of Midwestern farmland miles from the nearest metropolitan area.

Additional History

By 1975, Tarkio College had extended its adult education services to 34 Missouri cities. A first degree-completion program was established in Brentwood, near St. Louis. Other branch sites were created, with administrative offices in Brentwood, Jefferson City, Lee's Summit, Springfield and Trenton, Missouri. While these sites did not offer four-year programs, they nonetheless demonstrated the continuing growth of Tarkio College into the last quarter of the 20th century.

Tarkio College remained a viable institution until financial issues coupled with the loss of accreditation in the late 1980s and bankruptcy in 1991 led to its permanent closing on June 23, 1991. After Tarkio College filed for bankruptcy, the campus was divided at auction with First Bank Investors' Trust, a New York banking firm in control of most of the campus properties. Heartland Education Institute, Inc. (HEI), a local not-for-profit organization purchased Schechter Gymnasium in 1994. In 2002, the Tarkio R-I School District purchased 15.05 acres directly south of Schechter Gymnasium including the football field. In December 2004, HEI purchased the rest of the campus properties

³³ Ibid.

United States Department of the Interior
National Park Service

National Register of Historic Places Continuation Sheet

Section number 8 Page 19

Rankin Hall
Atchison County, Missouri

including Rankin Hall.³⁴

³⁴ Craig and Naylor, 107-112.

United States Department of the Interior
National Park Service

National Register of Historic Places Continuation Sheet

Section number 9 Page 20

Rankin Hall
Atchison County, Missouri

Bibliography:

Primary

Atchison County Deed Book. "Articles of Association of the Tarkio College." Book 37, February 14, 1885, 526-533.

_____. Warranty Deed, Book 47, (June 18, 1892), 625.

Canfield, H. Clyde, fifth president of Tarkio College. "Financial/Fact Sheet of Tarkio College," Tarkio College Alumni Archives, Tarkio, MO (1959).

Collins, Gordon Dixon, professor of psychology, 1963-2000 (College of Wooster, Wooster, Ohio) and son of Dr. M. Earle Collins, fourth president of Tarkio College (1932-1951), Wooster, Ohio. Phone interview by Joni Amthor, September 6, 2009, Tarkio, MO.

_____. "The Merits of Rankin Hall." Comments on Rankin Hall sent to Joni Amthor, September 16, 2009, Tarkio, MO.

Collins, M. Earle, fourth president of Tarkio College. Tarkio College Bulletin, Commencement Issue, s 43, no. 4 (April 1947).

Noble, Dr. Hubert C., Gen. Dir. "Fact Sheet—National Christian College Day." New York: Commission on Christian Higher Education, National Council of Churches, April 15, 1956.

Patterson, Professor R. F. "Tarkio Psychology Experiments." *The United Presbyterian* 96, no. 25 (June 23, 1938): 14.

Smith, T. Berry. *Historic Sketch of the Missouri College Union*/Compiled from Original Sources. Fayette: Advertiser Printing, c1925.

St. Clair, Kenneth E., professor of history emeritus. "Tarkio College History." Tarkio College, n.d.

"Story in Pictures of Tarkio College's Seven-Project Development Program, During the Years 1945-1950, at an Expenditure of \$600,000." *The United Presbyterian* 108, no. 31 (31 July 1950).

The Tarkio Avalanche. (Tarkio, MO). February 25, 1888-October 27, 1910,

United States Department of the Interior
National Park Service

National Register of Historic Places Continuation Sheet

Section number 9 Page 21

Rankin Hall
Atchison County, Missouri

November 26, 1915, January 24, 1930–October 16, 1931, March 28, 1952, May 25–June 15, 2006.

_____. Special Section: “1884 -1984 Tarkio’s Progress...Through the Pages of the Avalanche.” July 26, 1984, sec B, 1-48.

Tarkiana. (College yearbook, Tarkio, MO), 1971.

Tarkio College Board of Directors 1951-1952, support letter to William Kirk, Ph.D.
Tarkio College Alumni Archives, Tarkio, MO, n.d.

Tarkio College Bulletins: Fifth to Seventy-Sixth Annual Catalogues for the years 1887-1959. Tarkio, MO: Tarkio College, 1887-1959 .

The Tarkio College Torch. (Student Newspaper, Tarkio, MO). December 16, 1930–October 20, 1931.

The Tarkio Independent. (Tarkio, MO). January 22, 1892, April 22, 1904–May 31, 1907.

Thompson, Joseph Addison. “Tarkio College A Brief History.” Tarkio College Bulletin, Fiftieth Anniversary Celebration Edition, s 29, no. 3 (October 4, 1933), 7-15.

_____. “Tarkio College—Why It Should be Promptly Rebuilt.” *The United Presbyterian* (February 27, 1930).

Secondary

Craig, Cathryn Coe and Jone Craig Naylor. *Tarkio College 1883-1992, An Illustrated History of the “Crown of the Hill.”* Rock Port, MO: Family First Publications, 1992.

Gowans, Alan. *Styles and Types of North American Architecture: Social Function and Cultural Expression*. New York: Harper Collins, 1992.

Grashof, Bethanie C. “Historic American Buildings Survey (HABS No. Mo-1224)—Rockford School, Jackson County, Missouri.” September 1978.

Hammett, Ralph W. *Architecture in the United States: A Survey of Architectural Styles since 1776*. New York: John Wiley & Sons, 1976.

Harris, Cyril M., ed. *Illustrated Dictionary of Historic Architecture*. New York: Dover

United States Department of the Interior
National Park Service

National Register of Historic Places Continuation Sheet

Section number 9 Page 22

Rankin Hall
Atchison County, Missouri

Publications, Inc., 1977.

Hersey, George L. *High Victorian Gothic: A Study in Association*. Baltimore, MD: The Johns Hopkins Press, 1972.

The History of Holt and Atchison Counties, Missouri. St. Joseph, MO.: National Historical Company, 1882.

Monmouth College. "College History of Monmouth College." Monmouth College, Monmouth, IL, 2008. <http://www.monm.edu/aboutus/history.aspx>

Muskingum College. "About Muskingum College." Muskingum College, New Concord, Ohio, July 1, 2009. <http://www.muskingum.edu/home/about/overview.html>

Ohman, Marian M. "*Oh! Justice... .*" *The History of Boone County, Missouri Courthouses*. Columbia, MO: University of Missouri-Columbia Extension Division, 1979.

"The 100 Most Important Americans of 20th Century," *Life Magazine*, Special Issue Fall 1990, Vol.13, No. 12, 76.

Skelton, S. W. "Early History of Atchison County." Unpublished, Atchison County, MO, 1954, 1-24.

Stanton, Phoebe B. *The Gothic Revival & American Church Architecture: An Episode in Taste 1840-1856*. Baltimore, MD: The John Hopkins Press, 1968.

Tarkiana, Tarkio College yearbook, 1924 and 1931.

Tarkio: the First 100 Years. Shawnee Mission, KS: Kes-Print, [S.I.: s.n., 1980?]

Whiffen, Marcus and Frederick Koeper. *American Architecture 1607-1976*. Cambridge, MA: The MIT Press, 1981.

Williams, Walter, ed. *A History of Northwest Missouri*. Chicago and New York: Lewis Publishing Co., 1915.

Withey, Henry F. and Elsie Rathburn Withey. *Biographical Dictionary of American Architects (Deceased)*. Los Angeles: Hennessey & Ingalls, Inc., 1970.

United States Department of the Interior
National Park Service

National Register of Historic Places Continuation Sheet

Section number 11 Page 23

Rankin Hall
Atchison County, Missouri

11. Form Prepared By

1. Joni Amthor
23210 190th St.
Tarkio, MO 64491
(660) 736-5596
September 18, 2009
Original preparer
2. Roger Maserang
Historian/State Historic Preservation Office
P.O. Box 176
Jefferson City, MO 65102
(573) 522-4641
December 28, 2009
Additional research, writing and editing

United States Department of the Interior
National Park Service

National Register of Historic Places Continuation Sheet

Section number Photo log Page 24

Rankin Hall
Atchison County, Missouri

Photo Log:

The following is true for photographs #1-22:

Rankin Hall
Atchison County, Missouri
Photographers: Barry and Matthew Amthor
Date of photos: April 21, 2005 and June 8, 2006
Photo type: Digital

The following is true for photographs #23-28:

Rankin Hall
Atchison County, Missouri
Photographer: Robert N. Montgomery, Tarkio College president, 1930-1932
Date of photos: January 1930-1931
Location of negatives: Unknown. Source: Tarkio College Alumni Association Archives

1. East side of building, looking west
2. East side of building, looking northwest
3. West side of upper T section, looking east
4. East side of building, main entrance facing street to east
5. East side of building, main entrance, arched doorway
6. East side of building, window on second floor
7. North side of entrance looking southwest
8. Stone detail around third floor windows and copper gutter
9. West side of building, looking southeast
10. West side of building, looking east
11. North side of chapel, looking south
12. West side of chapel, looking east
13. South side of chapel, looking north
14. North side of upper T section of building, looking south
15. Arch above main entrance from inside facing east
16. Terrazzo marble floor tile, main entrance to second floor
17. Interior of oriel window on second floor, looking east
18. Stained glass window in chapel
19. Sculptured details along ceilings
20. Doors leading into chapel on second floor at top of main stairway
21. Chapel stage, west end of building, second floor
22. Original lamp in chapel
23. Architect's sketch, south and east sides, looking northwest

United States Department of the Interior
National Park Service

National Register of Historic Places Continuation Sheet

Section number Photo log Page 25

Rankin Hall
Atchison County, Missouri

24. Construction: basement, base of entrance on east side
25. Construction: second floor completed, east side, looking west
26. Construction: roof going up, southwest side, looking northeast
27. Graduation ceremony after building completed
28. Interior of first library

United States Department of the Interior
National Park Service

National Register of Historic Places Continuation Sheet

Section number Figures Page 26

Rankin Hall
Atchison County, Missouri

Figure 1: Basement Floor Plan (Original floor plans are in maintenance building on Tarkio College campus.)

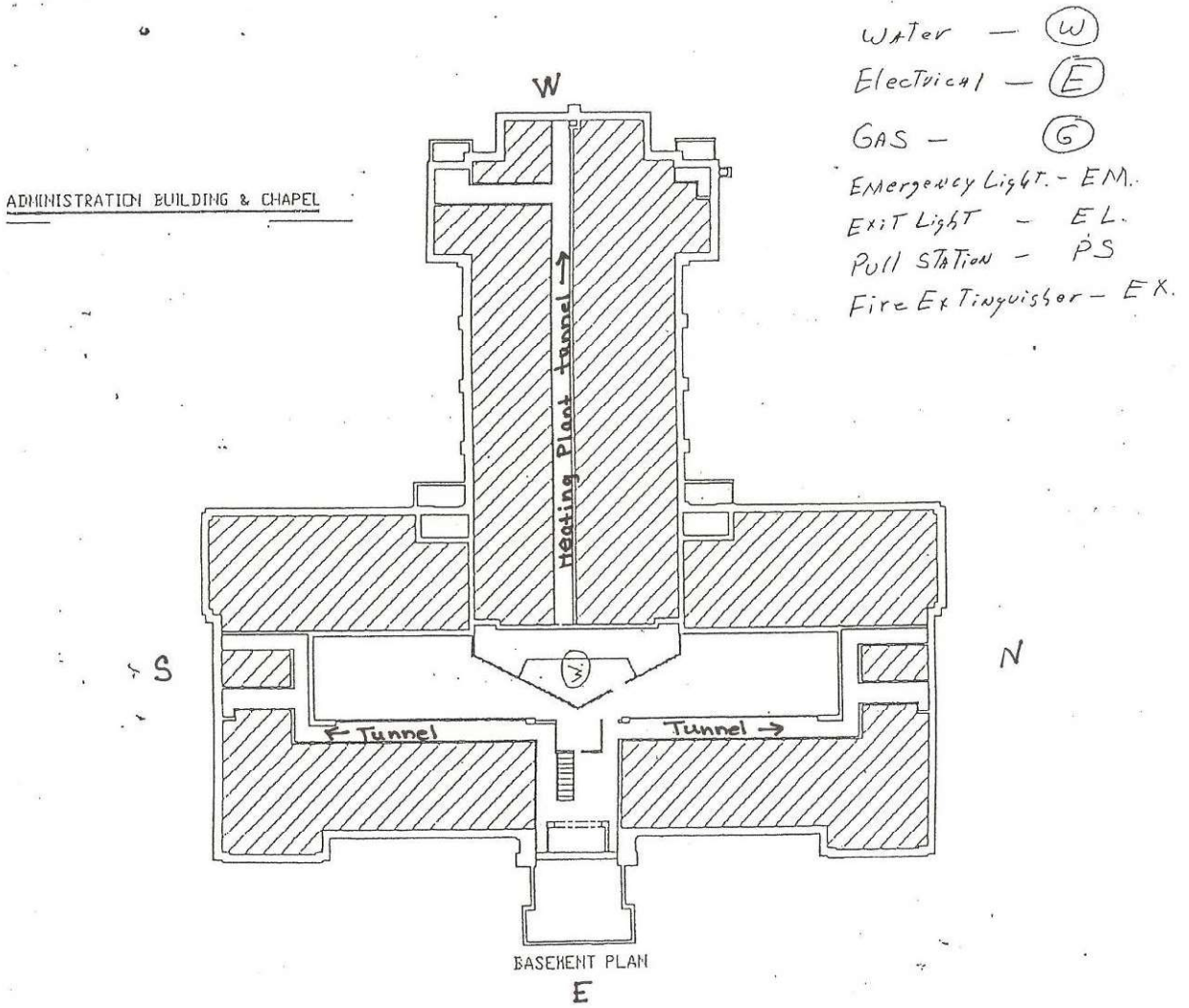

United States Department of the Interior
National Park Service

National Register of Historic Places Continuation Sheet

Section number Figures Page 27

Rankin Hall
Atchison County, Missouri

Figure 2: First Floor Plan (Original floor plans are in maintenance building on Tarkio College campus.)

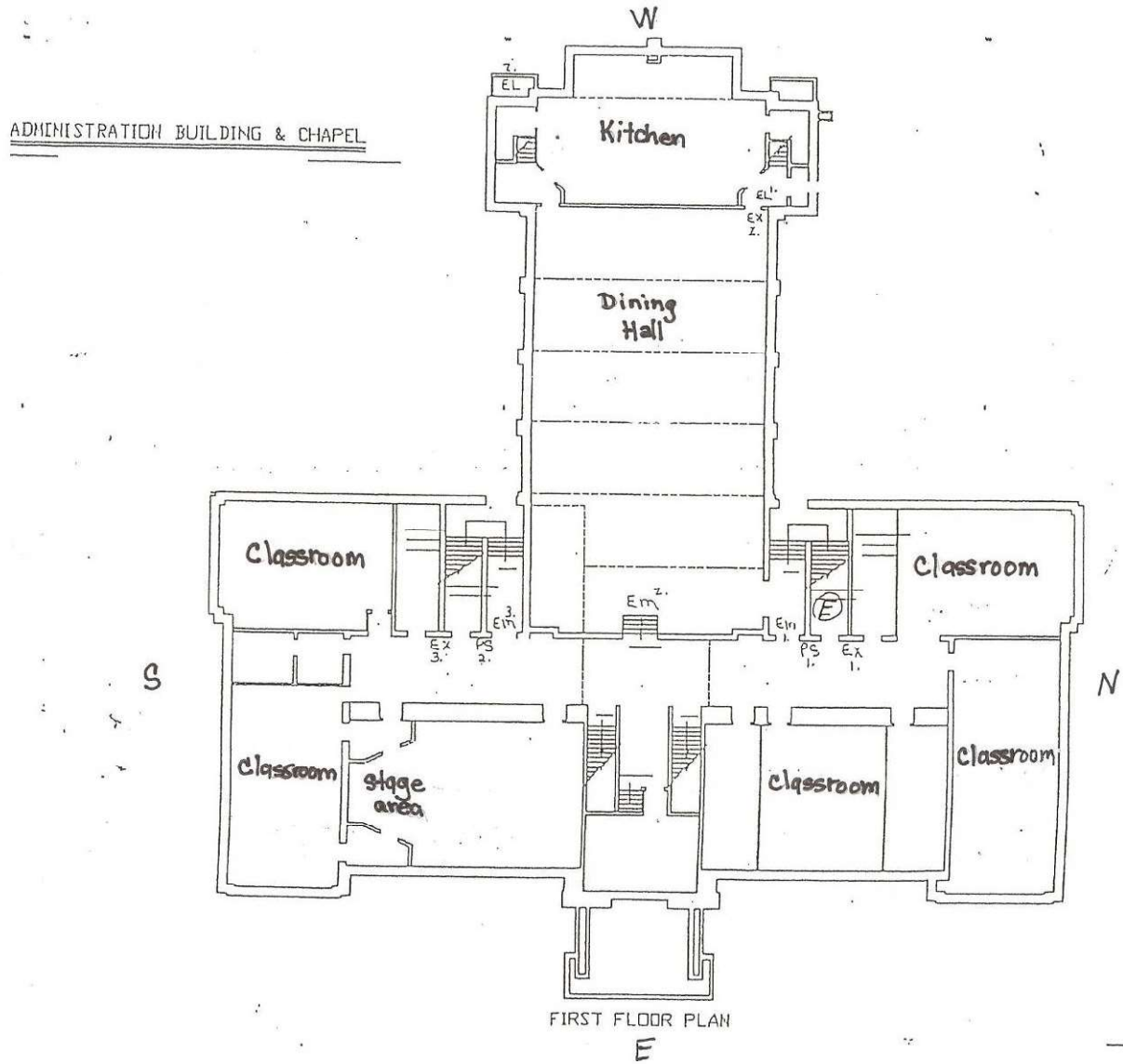

United States Department of the Interior
National Park Service

National Register of Historic Places Continuation Sheet

Section number Figures Page 28

**Rankin Hall
Atchison County, Missouri**

Figure 3: Second Floor Plan (Original floor plans are in maintenance building on Tarkio College campus.)

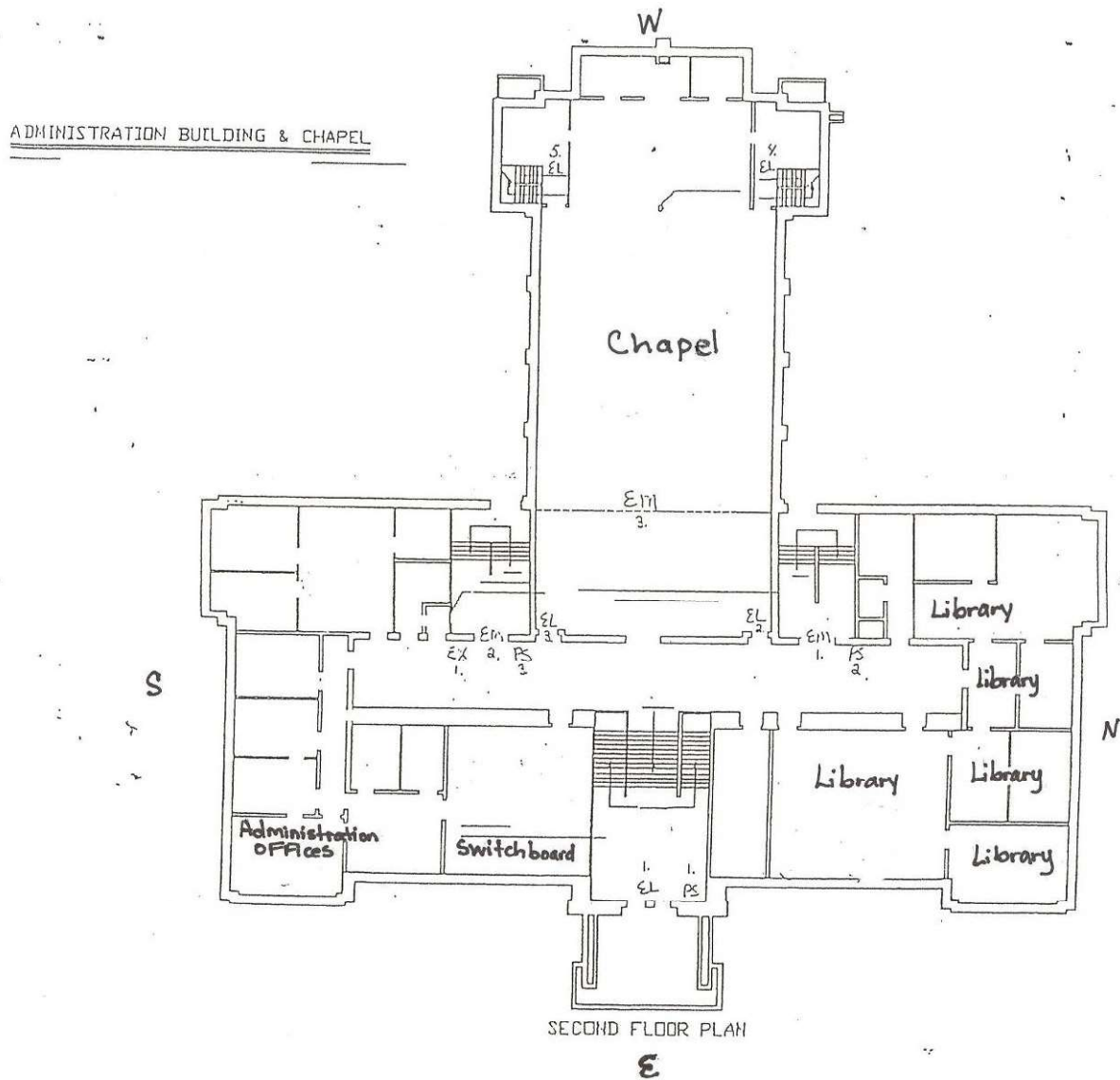

United States Department of the Interior
National Park Service

National Register of Historic Places Continuation Sheet

Section number Figures Page 29

Rankin Hall
Atchison County, Missouri

Figure 4: Third Floor Plan (Original floor plans are in maintenance building on Tarkio College campus.)

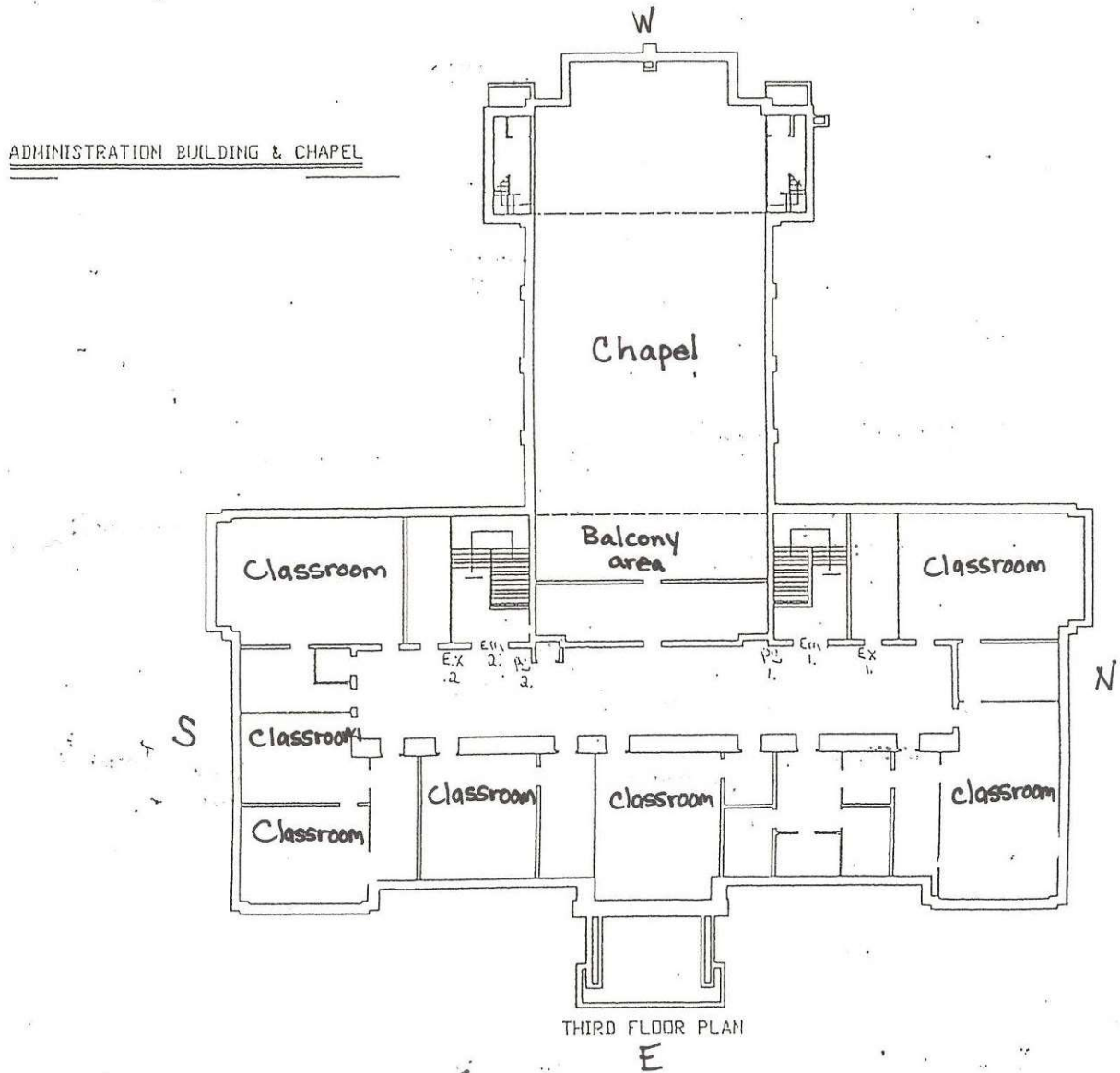

United States Department of the Interior
National Park Service

National Register of Historic Places Continuation Sheet

Section number Figures Page 30

Rankin Hall
Atchison County, Missouri

SEPT. 12. 1930.

PLANS FOR THE ADMINISTRATION BLDG. & CHAPEL
TARKIO COLLEGE, TARKIO, MO.
FELT, DUNHAM & KRIEHN ARCHTS. KANSAS CITY, MO. 1930.

GENERAL PLAN CONSISTS OF SKTS. 1-16, INC.
HTG. & PLQ " " " 1-2-3-5-6-7-9-10-13
ELEC. WIRING " " " 1-2-3-5-6-7-9.

Figure 5: Architectural design of primary east side (north end): Felt, Dunham & Kriehn, Architects of Kansas City, MO, *Blueprints and General Plan of the Administration Building and Chapel of Tarkio College, Tarkio, MO, 12 September 1930.* (Original drawings are on file in the maintenance building on the Tarkio College campus.)

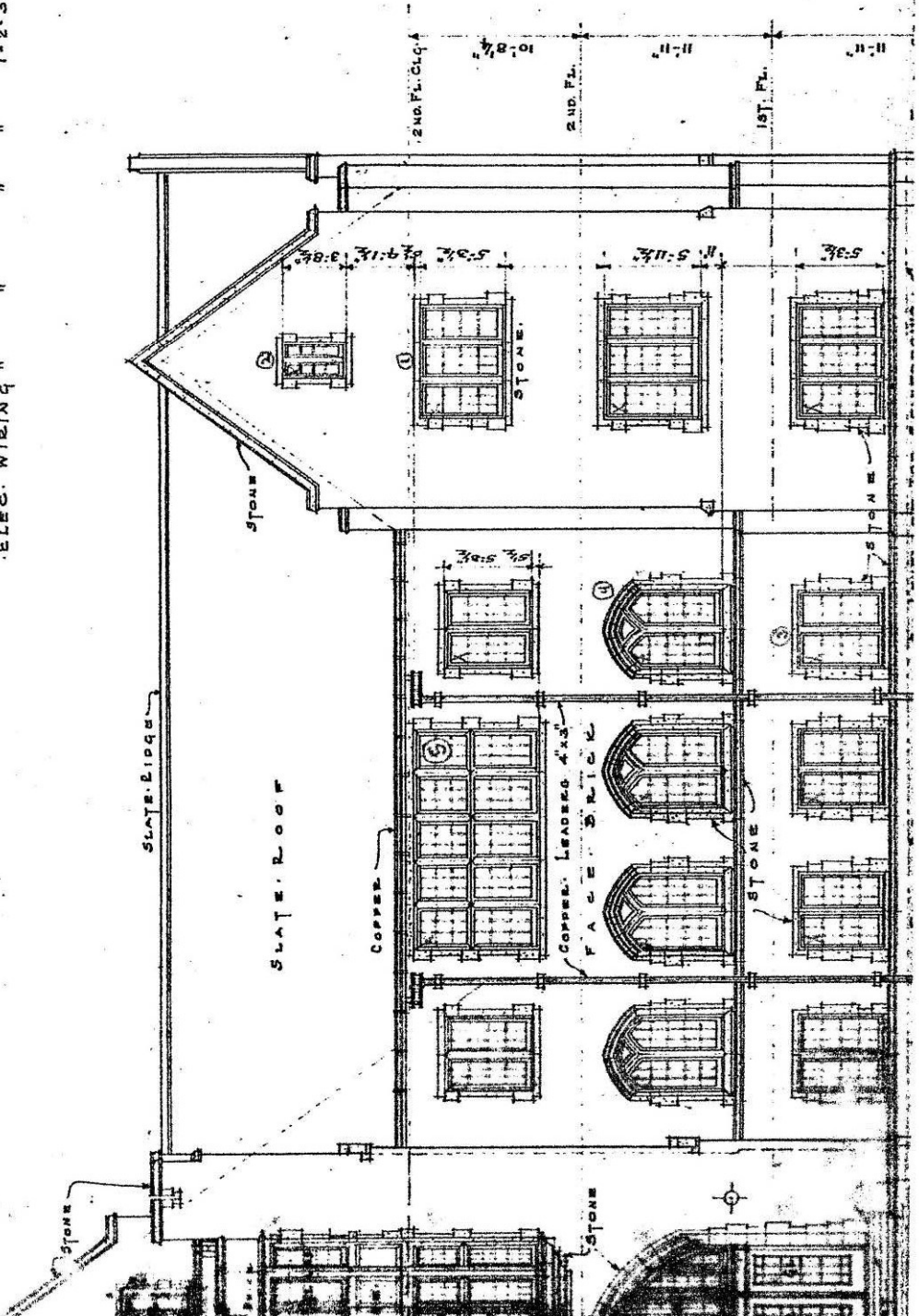

United States Department of the Interior
National Park Service

National Register of Historic Places Continuation Sheet

Section number Figures Page 31

Rankin Hall
Atchison County, Missouri

Figure 6: Architectural design of primary east elevation (north end): Felt, Dunham & Kriehn, Architects of Kansas City, MO, *Blueprints and General Plan of the Administration Building and Chapel of Tarkio College, Tarkio, MO, 12 September 1930.* (Original drawings are on file in the maintenance building on the Tarkio College campus.)

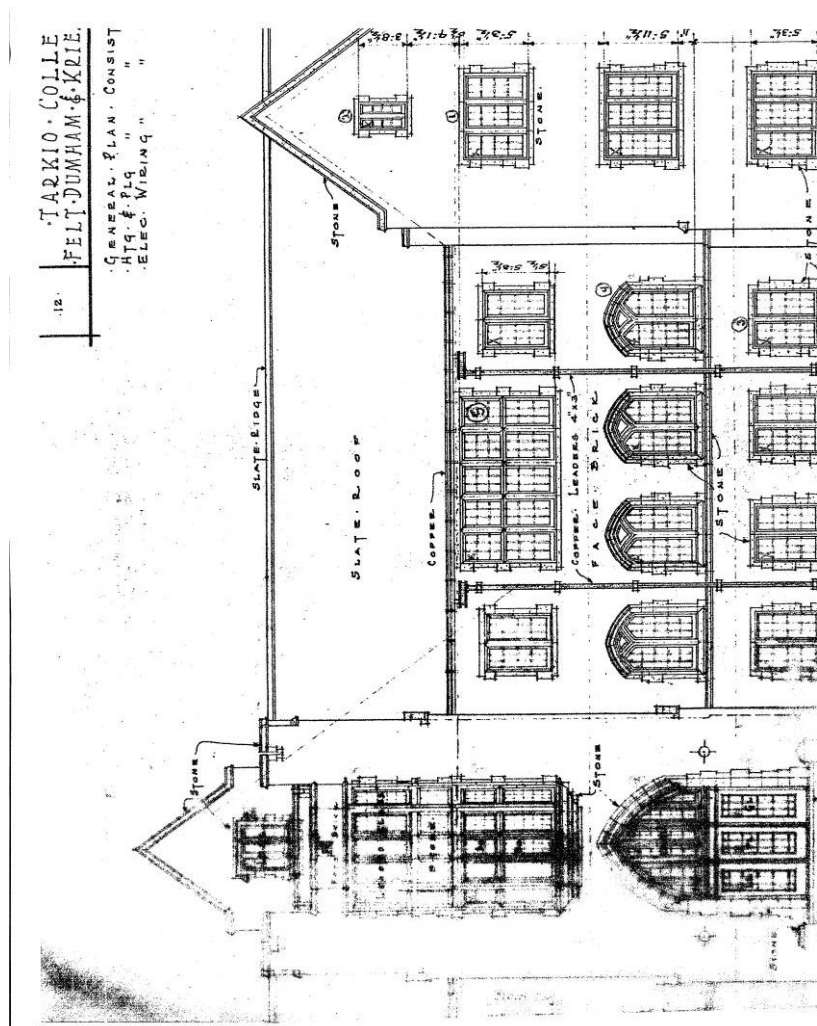

United States Department of the Interior
National Park Service

National Register of Historic Places Continuation Sheet

Section number Figures Page 32

Rankin Hall
Atchison County, Missouri

Figure 7: Architectural design of rear elevation (southwest side): Felt, Dunham & Kriehn, Architects of Kansas City, MO, *Blueprints and General Plan of the Administration Building and Chapel of Tarkio College, Tarkio, MO, 12 September 1930.* (Original drawings are on file in the maintenance building on the Tarkio College campus.)

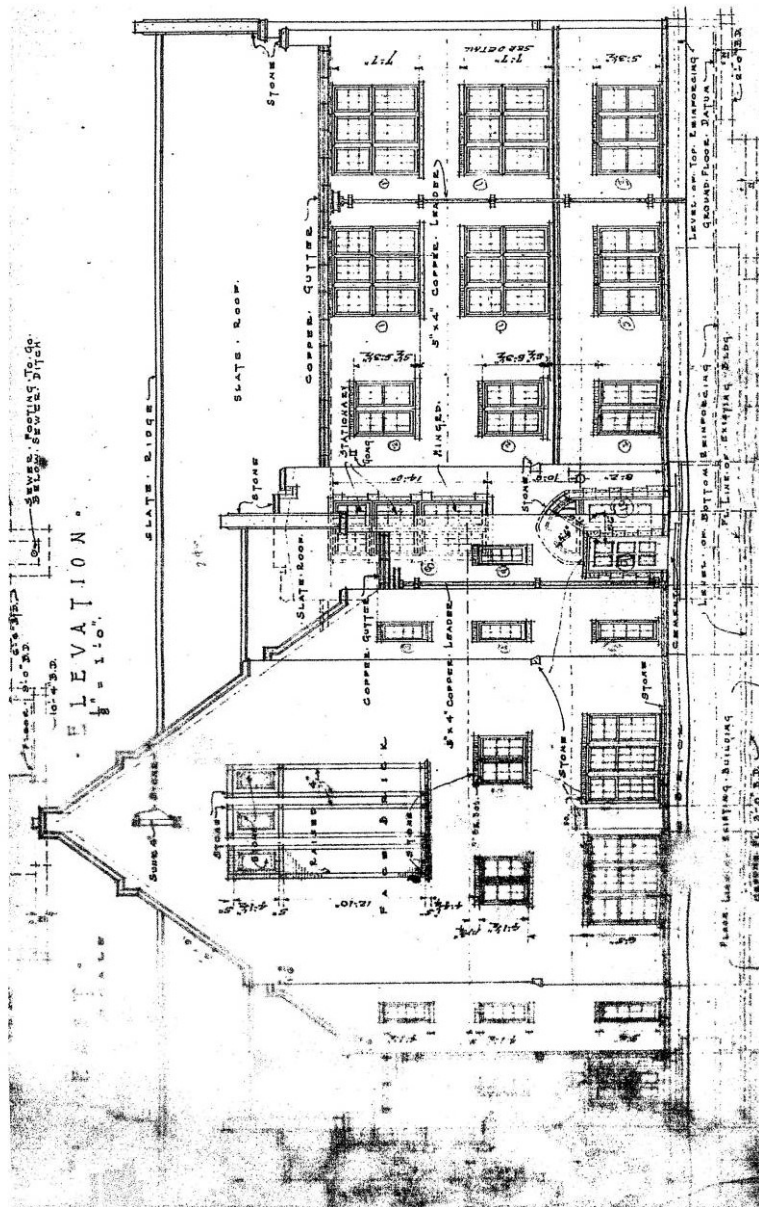

United States Department of the Interior
National Park Service

National Register of Historic Places Continuation Sheet

Section number Figures Page 33

Rankin Hall
Atchison County, Missouri

Figure 8: Architectural design of north elevation of chapel: Felt, Dunham & Kriehn, Architects of Kansas City, MO, *Blueprints and General Plan of the Administration Building and Chapel of Tarkio College, Tarkio, MO, 12 September 1930.* (Original drawings are on file in the maintenance building on the Tarkio College campus.)

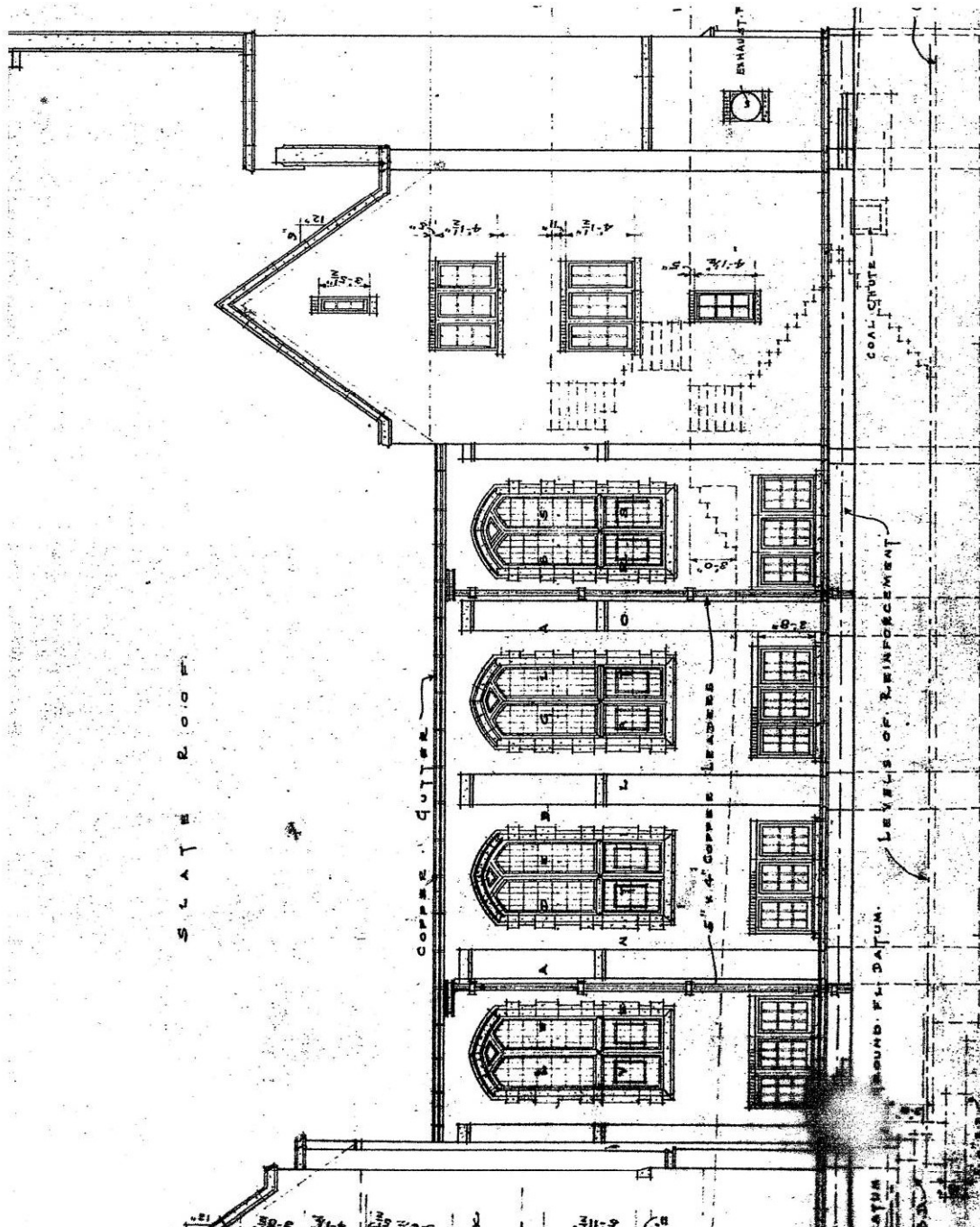

United States Department of the Interior
National Park Service

National Register of Historic Places Continuation Sheet

Section number Figures Page 34

Rankin Hall
Atchison County, Missouri

Figure 9: Missouri Land Survey of Tarkio College's Rankin Plat (Sketched by Wheaton E. Elkins, Savannah, MO, on July 9, 1965. Original on file with Raines Abstract, Rock Port, MO.)

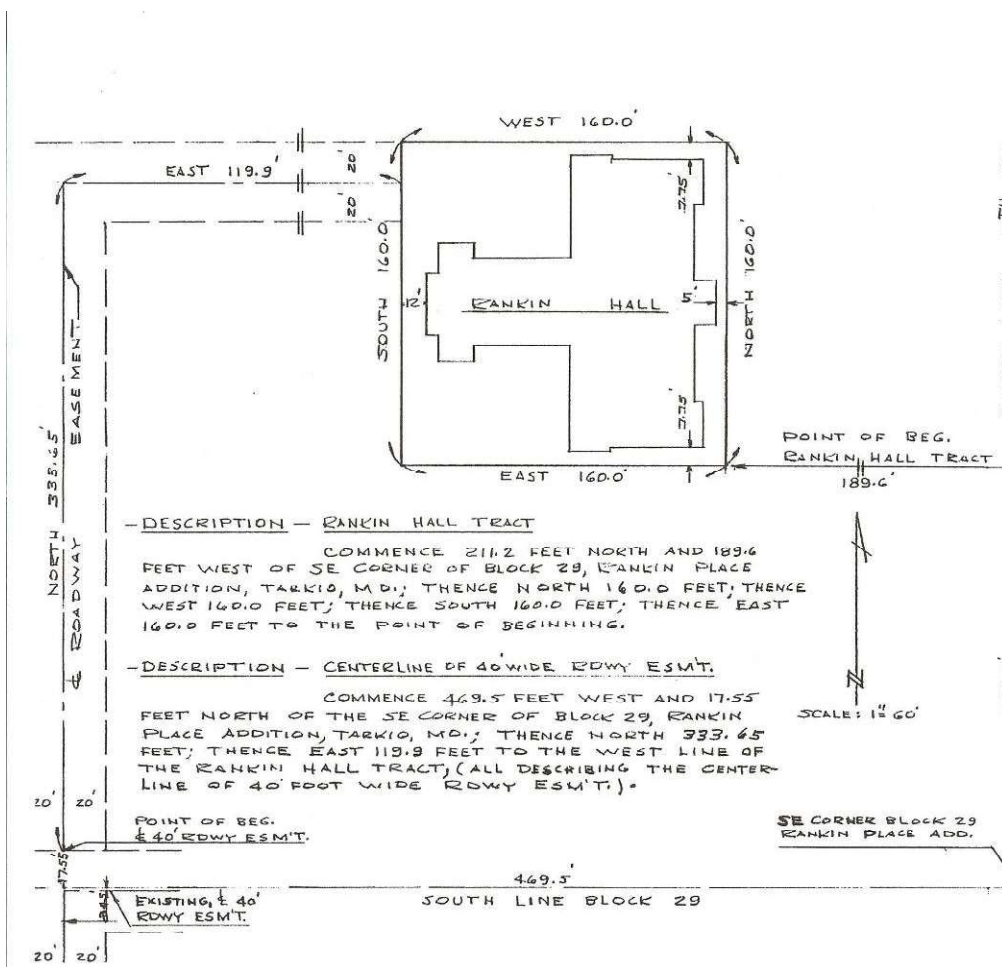

I CERTIFY THE ABOVE PLAT TO SHOW THE CORRECT RESULT OF A SURVEY COMPLETED JULY 9, 1965

Wheaton E. Elkins
 WHEATON E. ELKINS
 MO. L. S. - 825
 SAVANNAH, MO.

United States Department of the Interior
National Park Service

National Register of Historic Places Continuation Sheet

Section number Figures Page 35

Rankin Hall Atchison County, Missouri

Figure 10: Sketch map of Tarkio College (Source: Craig, Cathryn Coe and Jone Craig Naylor. *Tarkio College 1883-1992, An Illustrated History of the "Crown of the Hill."* Rock Port, MO: Family First Publications, 1992, 113.)

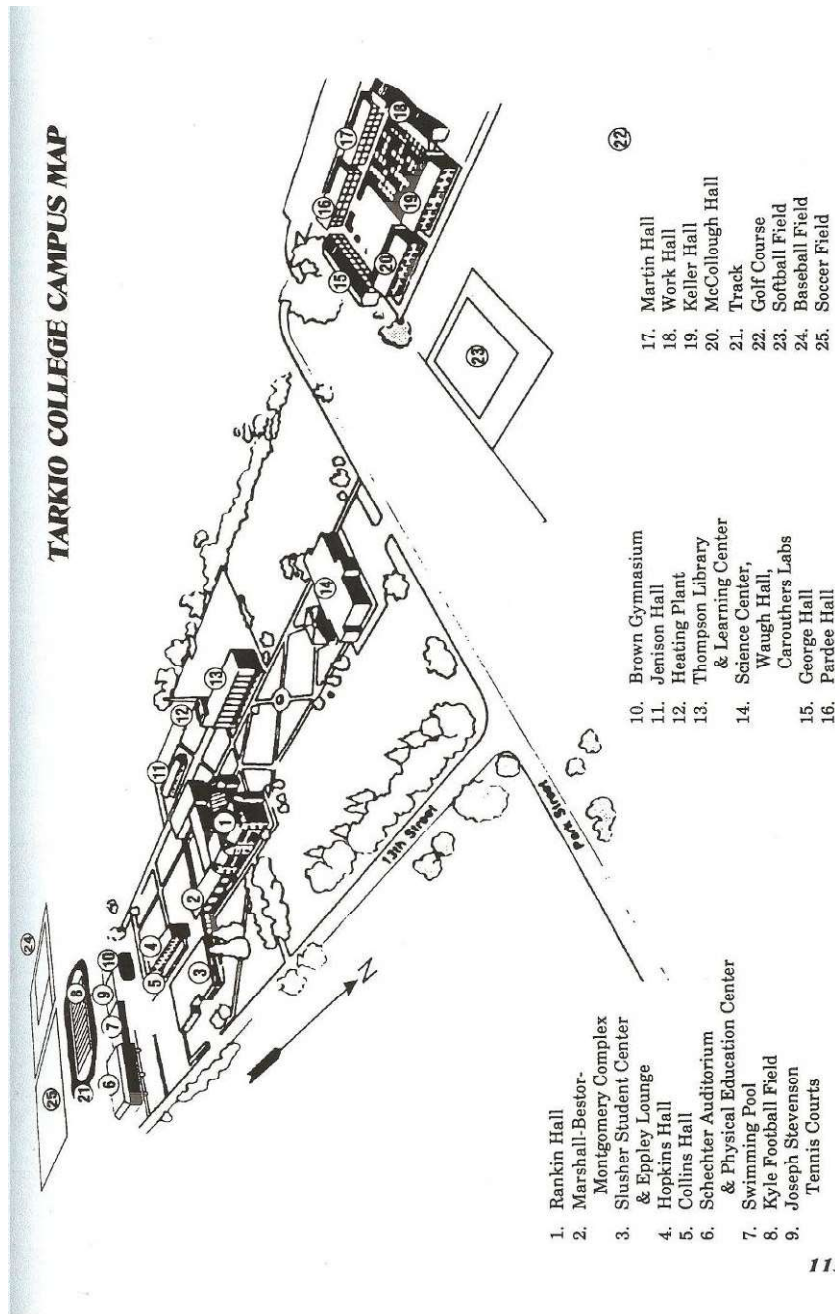

United States Department of the Interior
National Park Service

National Register of Historic Places Continuation Sheet

Section number Figures Page 36

Rankin Hall
Atchison County, Missouri

Figure 11: Survey Map of Tarkio College (Sketched by Troy Hayes, P.L.S., of Midland Surveys on December 15, 2004.)

United States Department of the Interior
National Park Service

National Register of Historic Places Continuation Sheet

Section number Figures Page 37

Rankin Hall
Atchison County, Missouri

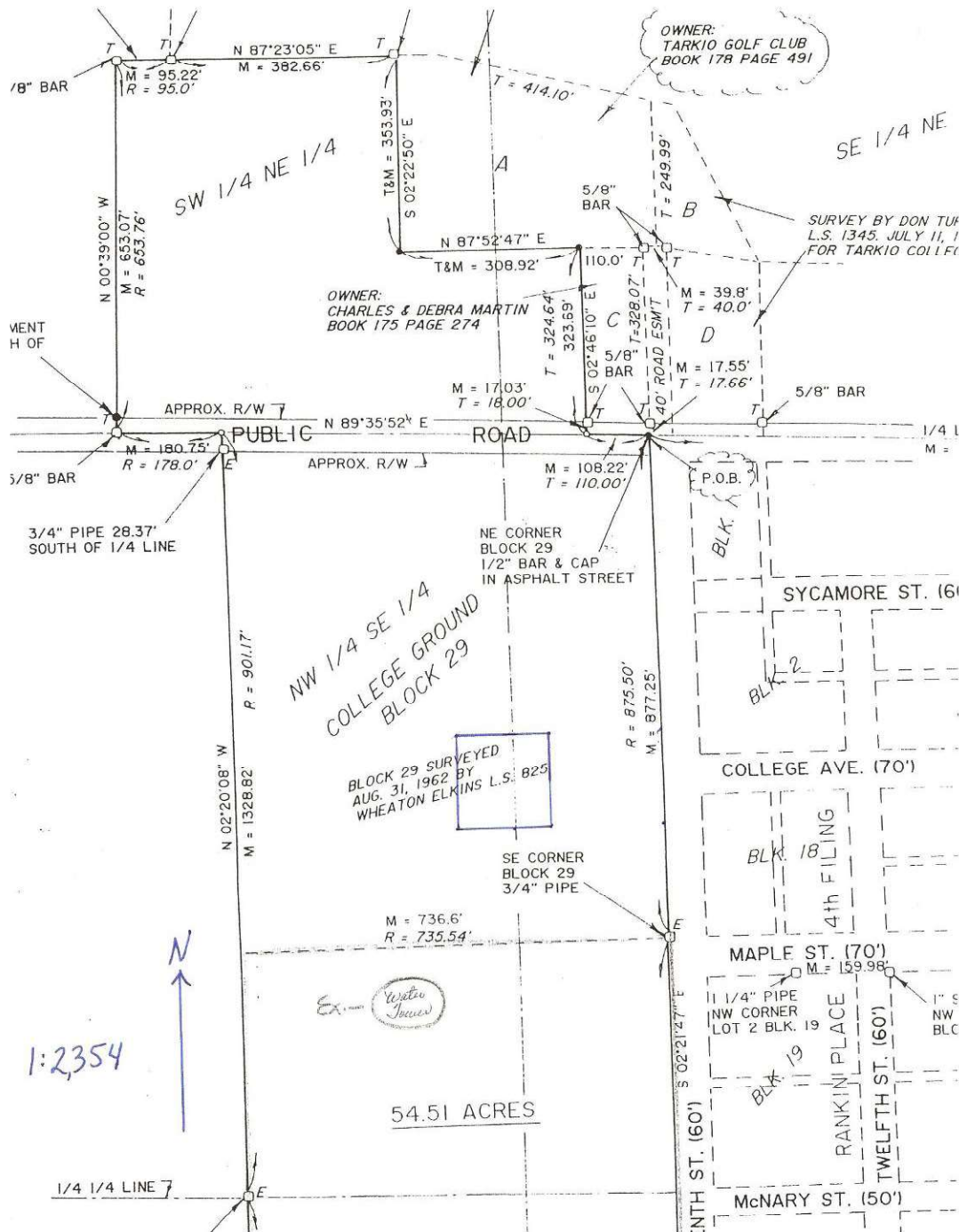

Figure 12: Aerial view of Tarkio College (Source: *Tarkiana* yearbook (1971), Tarkio College Alumni Association Museum, Tarkio, MO.)

United States Department of the Interior
National Park Service

National Register of Historic Places Continuation Sheet

Section number Figures Page 38

**Rankin Hall
Atchison County, Missouri**

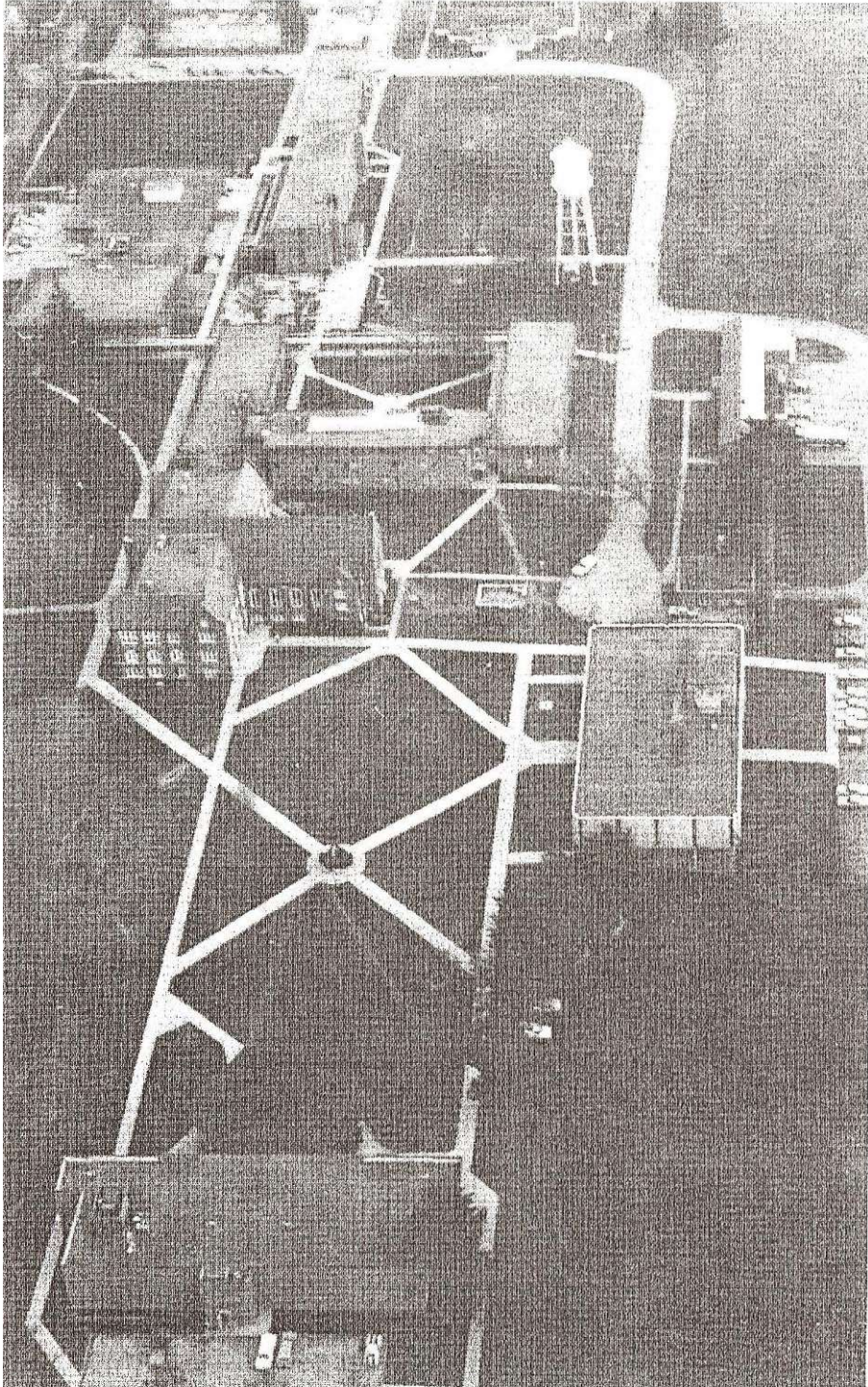

Figure
Photos

United States Department of the Interior
National Park Service

National Register of Historic Places Continuation Sheet

Section number Figures Page 39

Rankin Hall
Atchison County, Missouri

Muskingum College's Administration Building, New Concord, Ohio. Photographer, Ryan McLaughlin, reference librarian/web resource manager, Muskingum College Library Archives, July 14, 2009.



Tarkio West Quad

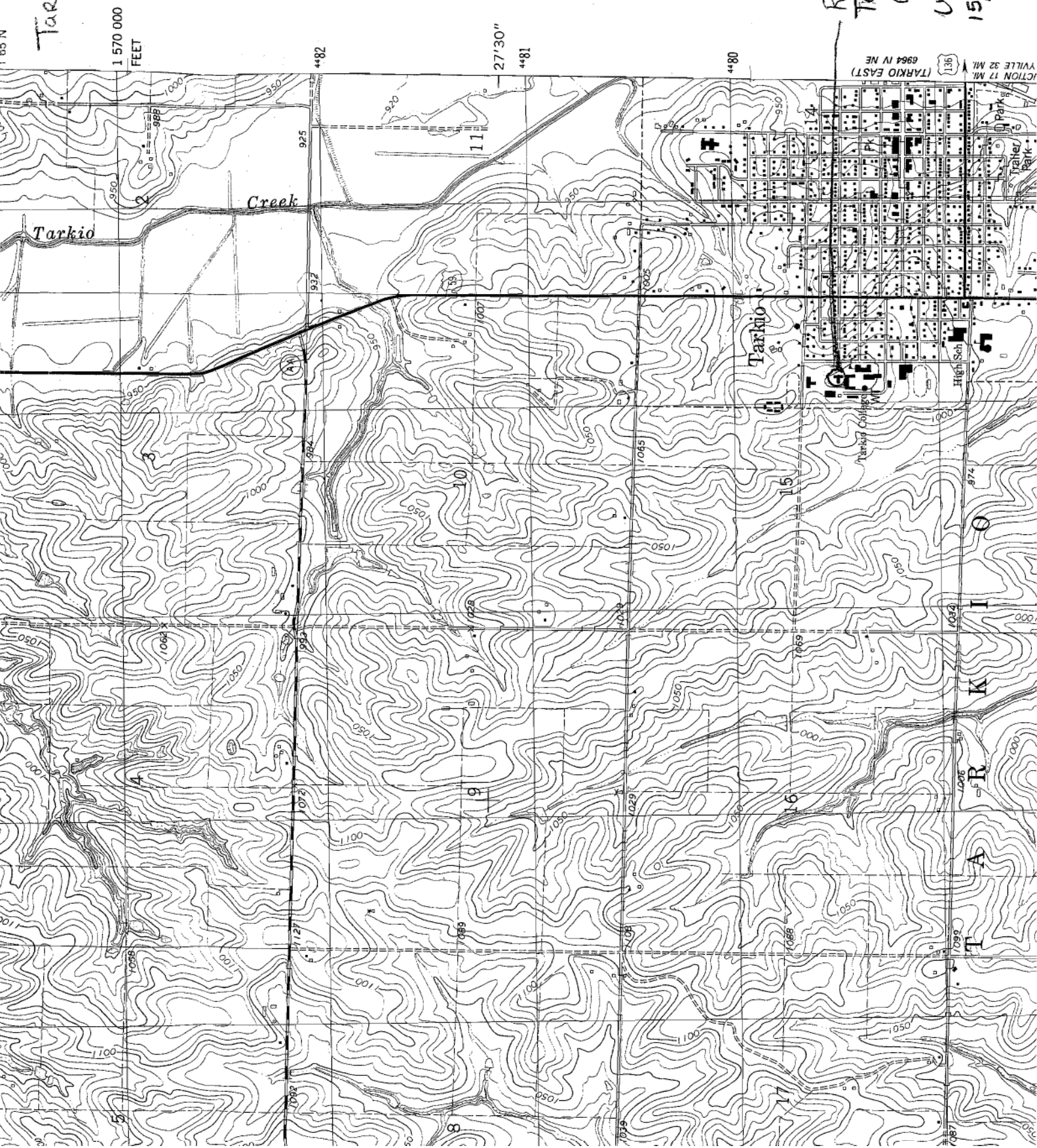

Rankin Hall
Tarkio, Atchison Co.,
Missouri
UTM Reference
15/297120/4479490







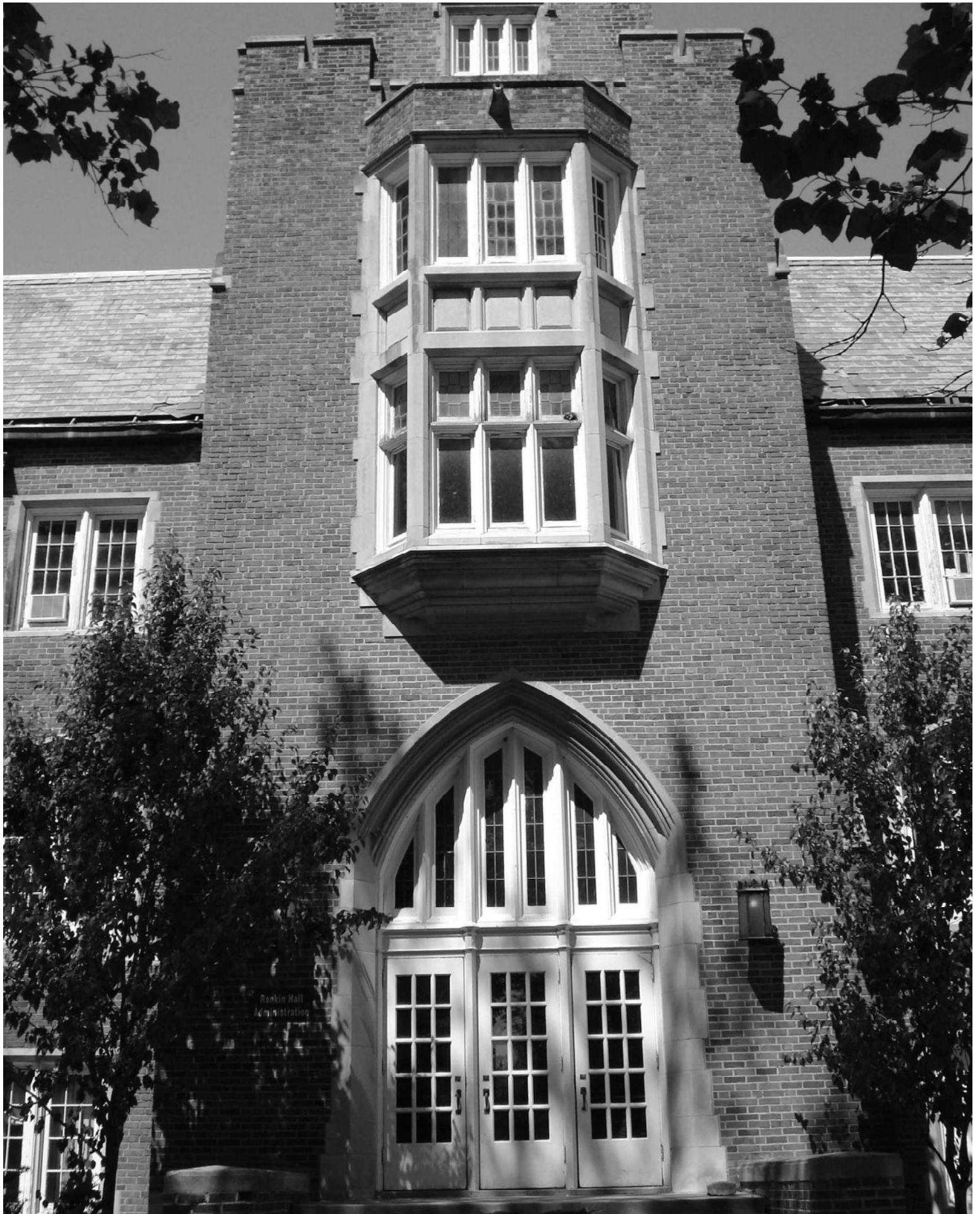

Rankin Hall
Administration

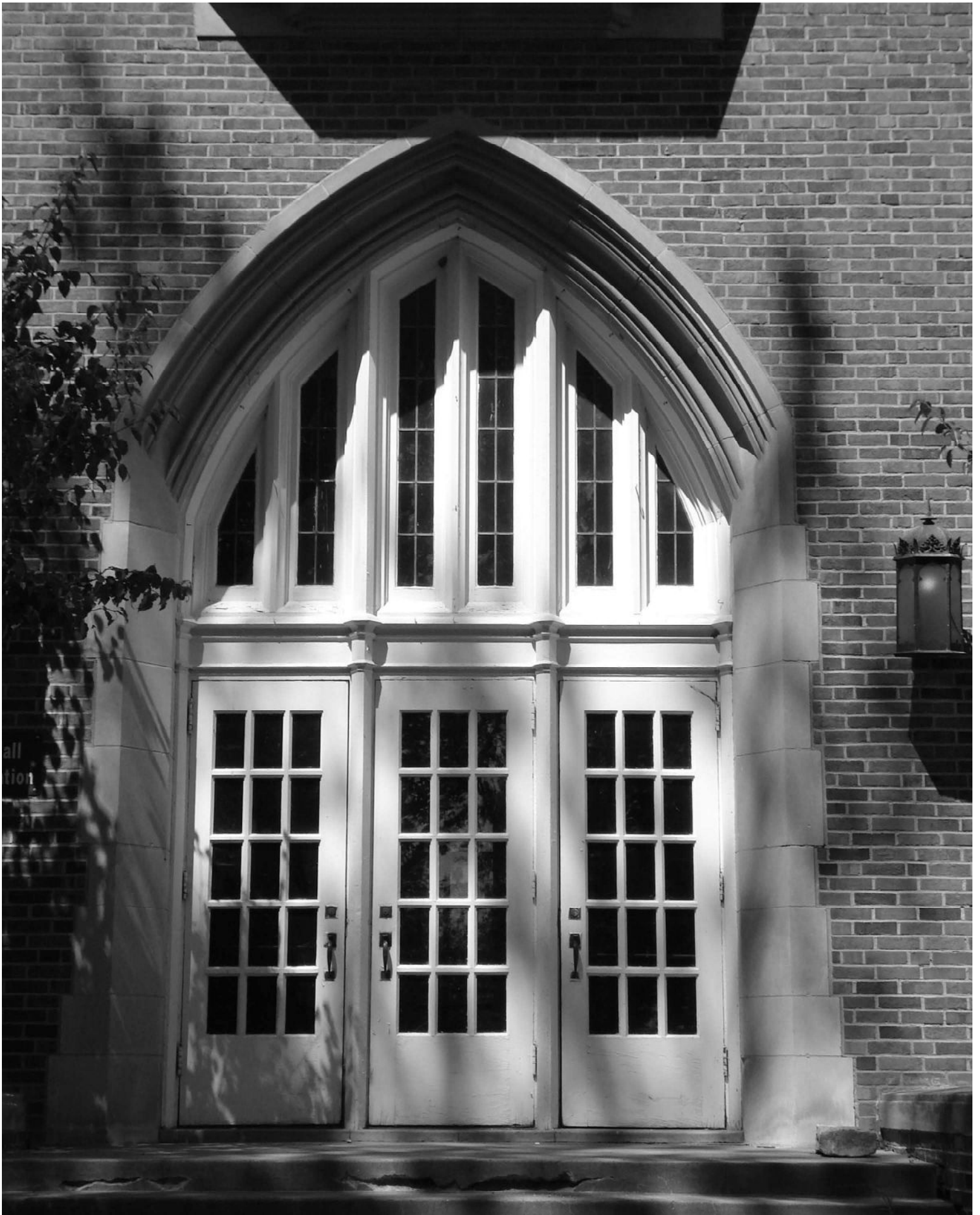





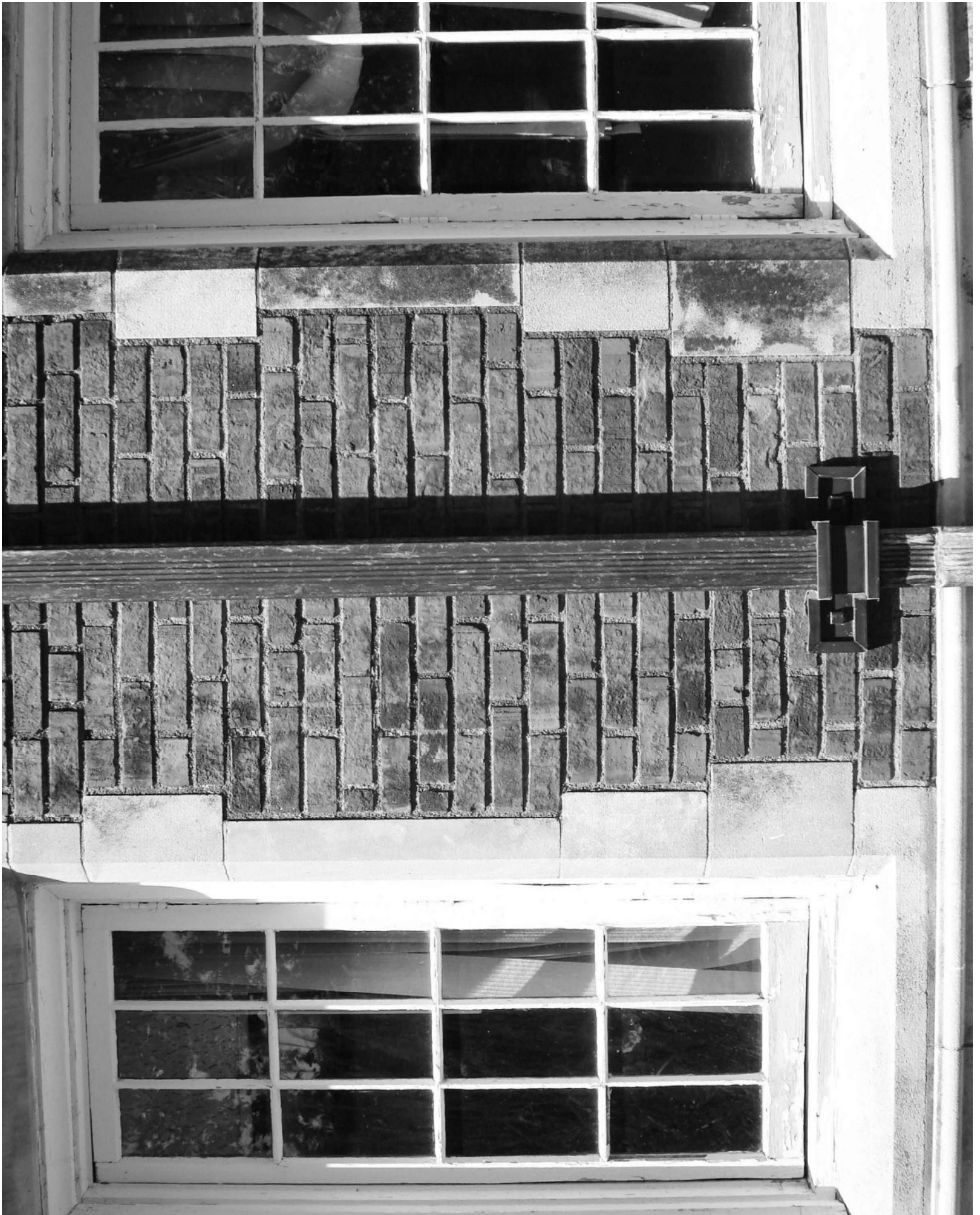





























CAPACITY
6000

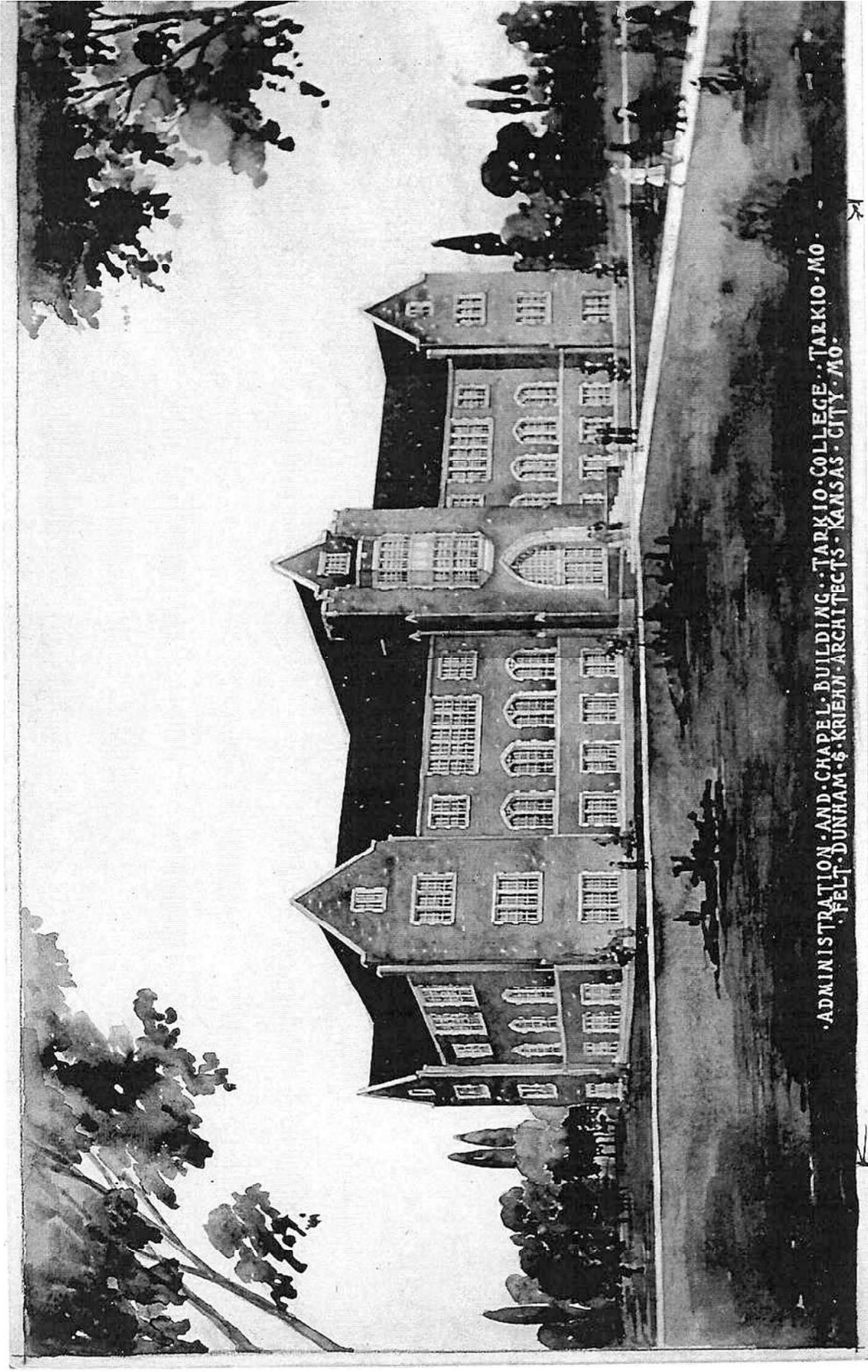

ADMINISTRATION AND CHAPEL BUILDING. TARKIO COLLEGE. TARKIO, MO.
FELT, DUNHAM & KRIEHN ARCHITECTS. KANSAS CITY, MO.

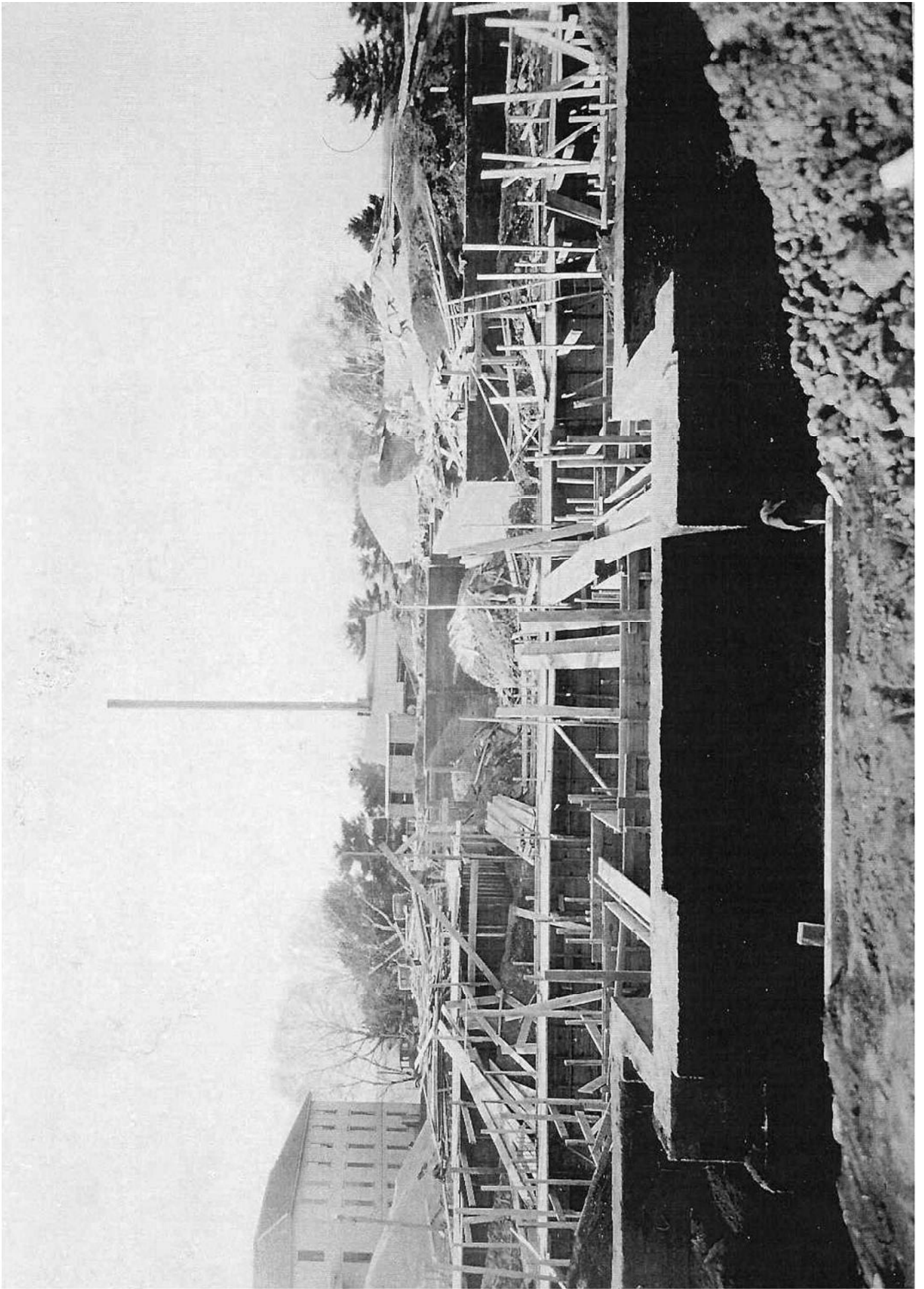



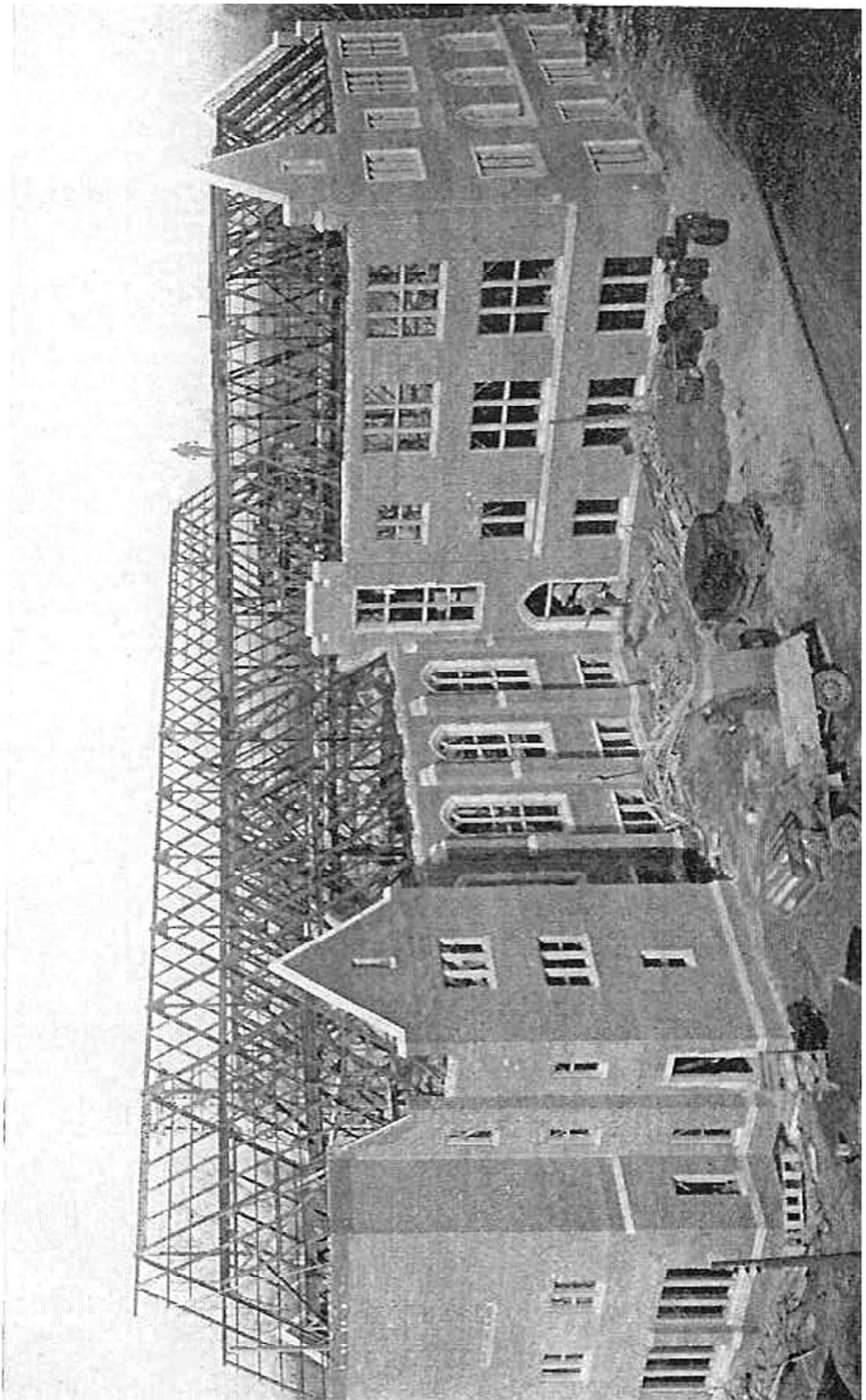

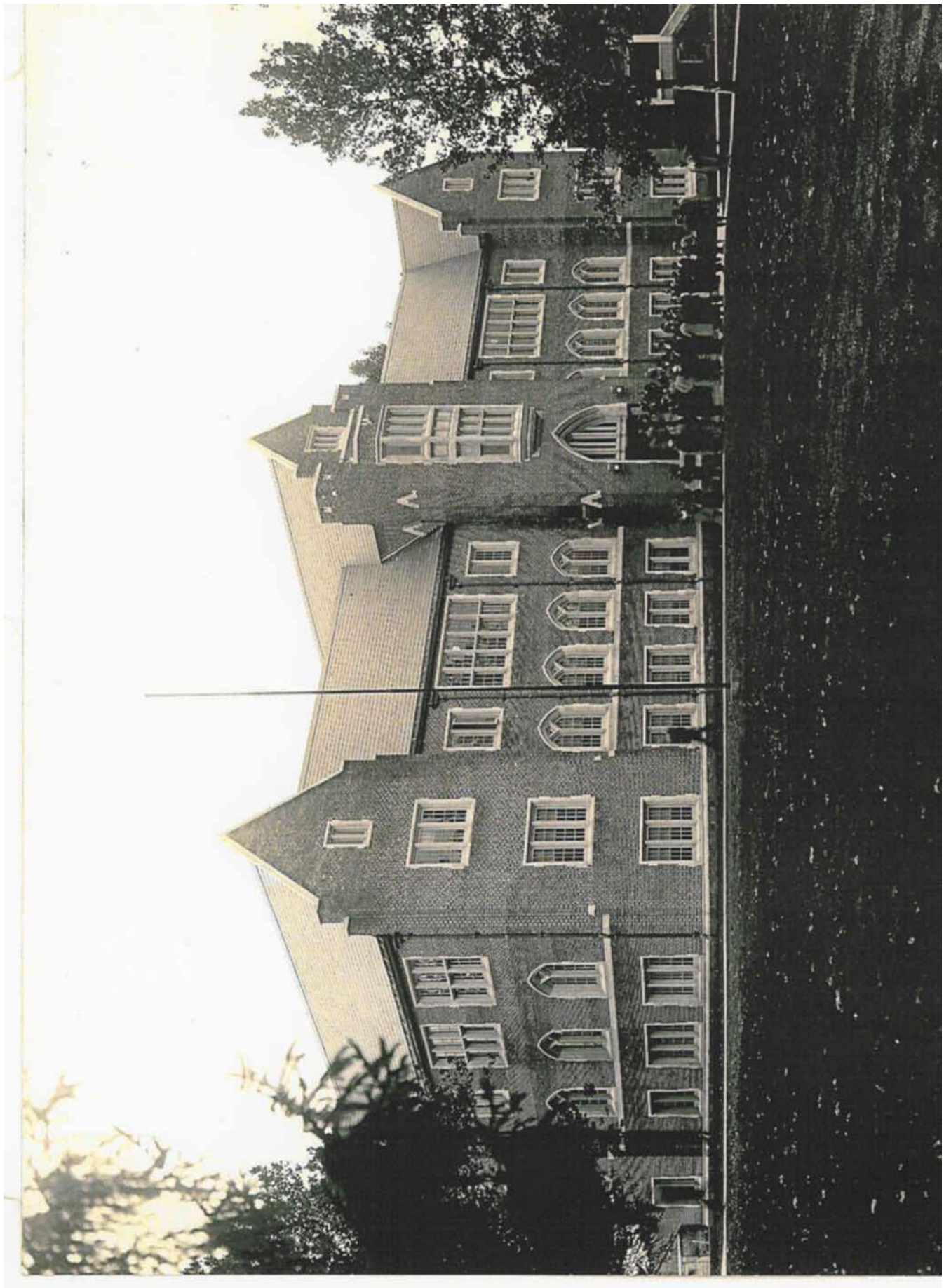



LIBRARY